

GLASS DOORS, FRAMES & FIFO SHELVING

*: available in different heights

MAXIMUM TRANSPARANCY



A CRYSTAL-CLEAR VIEW OF ALL YOUR FAST-MOVING CONSUMER GOODS

Technical	Dimensions (mm)		Electrical		ECO
Nr. of doors	W x H frame	useful dooropening	Nr. of lamps	T8 lighting	LED lighting

3018 Width = 30" - 760 mm - Height = 1806 mm - Type GIANT 2200

1	795 x 1844	706 x 1758	2	110 W	30 W
2	1564 x 1844	706 x 1758	3	165 W	54 W
3	2342 x 1844	706 x 1758	4	220 W	78 W
4	3123 x 1844	706 x 1758	5	275 W	102 W
5	3898 x 1844	706 x 1758	6	330 W	126 W

3016 Width = 30" - 760 mm - Height = 1601 mm - Type GIANT 2000

1	795 x 1639	706 x 1553	2	110 W	30 W
2	1564 x 1639	706 x 1553	3	165 W	54 W
3	2342 x 1639	706 x 1553	4	220 W	78 W
4	3123 x 1639	706 x 1553	5	275 W	102 W
5	3898 x 1639	706 x 1553	6	330 W	126 W

2618 Width = 26" - 660 mm - Height = 1806 mm - Type SUPER KING 2200

1	698 x 1844	608 x 1758	2	110 W	30 W
2	1372 x 1844	608 x 1758	3	165 W	54 W
3	2046 x 1844	608 x 1758	4	220 W	78 W
4	2722 x 1844	608 x 1758	5	275 W	102 W
5	3396 x 1844	608 x 1758	6	330 W	126 W

2616 Width = 26" - 660 mm - Height = 1601 mm - Type SUPER KING 2000

1	698 x 1639	608 x 1553	2	110 W	30 W
2	1372 x 1639	608 x 1553	3	165 W	54 W
3	2046 x 1639	608 x 1553	4	220 W	78 W
4	2722 x 1639	608 x 1553	5	275 W	102 W
5	3396 x 1639	608 x 1553	6	330 W	126 W

3021 Width = 30" - 760 mm - Height = 2102 mm - Type ROLL-IN 2200

1	795 x 2144	706 x 2095	2	160 W	38 W
2	1564 x 2144	706 x 2095	3	240 W	67 W
3	2342 x 2144	706 x 2095	4	320 W	96 W
4	3123 x 2144	706 x 2095	5	400 W	125 W
5	3898 x 2144	706 x 2095	6	480 W	154 W

3019 Width = 30" - 760 mm - Height = 1897 mm - Type ROLL-IN 2000

1	795 x 1939	706 x 1890	2	160 W	38 W
2	1564 x 1939	706 x 1890	3	240 W	67 W
3	2342 x 1939	706 x 1890	4	320 W	96 W
4	3123 x 1939	706 x 1890	5	400 W	125 W
5	3898 x 1939	706 x 1890	6	480 W	154 W

POSITIVE T° (FRN) - NEGATIVE T° (FRN) - ULTRABRIGHT (FRU)

POSITIVE T° (FRR)

GIANT / SUPER KING 2000 & 2200

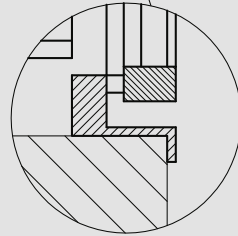
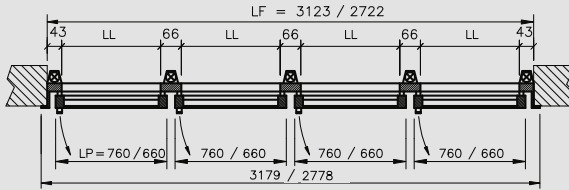
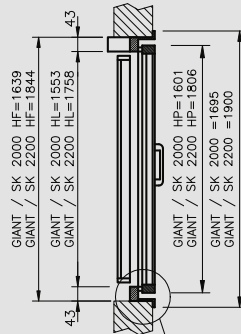
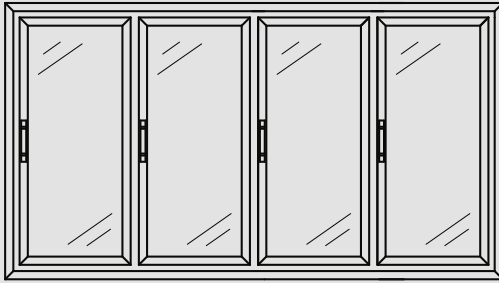

ROLL-IN 2000 & 2200

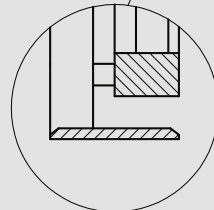
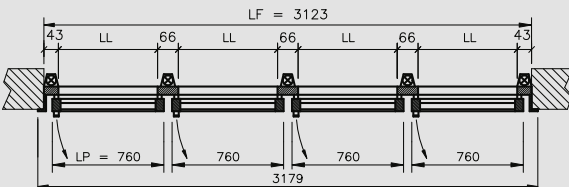
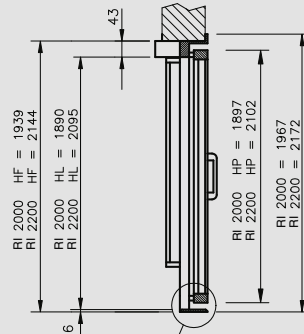
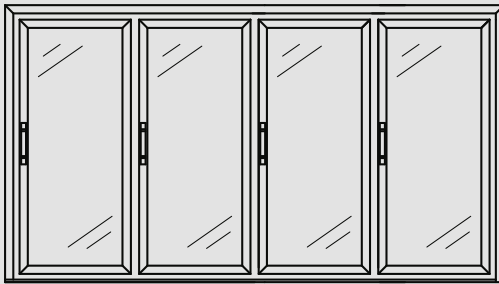

VERY EASY FILLING



ATTRACTIVE PRESENTATION WITH AN ELEGANT WHITE OR PURE BLACK DESIGN



FIFO shelving is **used intensively on a daily basis**. This during both the removal and the replenishment of products. Thanks to the special epoxy coating, Linum FIFO shelving is protected against wear and tear and corrosion. Moreover, the unique coating also **provides extra gliding capacity**.

LINUM FIFO SHELVING, THE ONLY SHELF YOU WANT IN YOUR GLASS DOOR WALL



Reinforced fixed wire shelves



Fixed shelves with rollers



Fixed shelves with closed surface

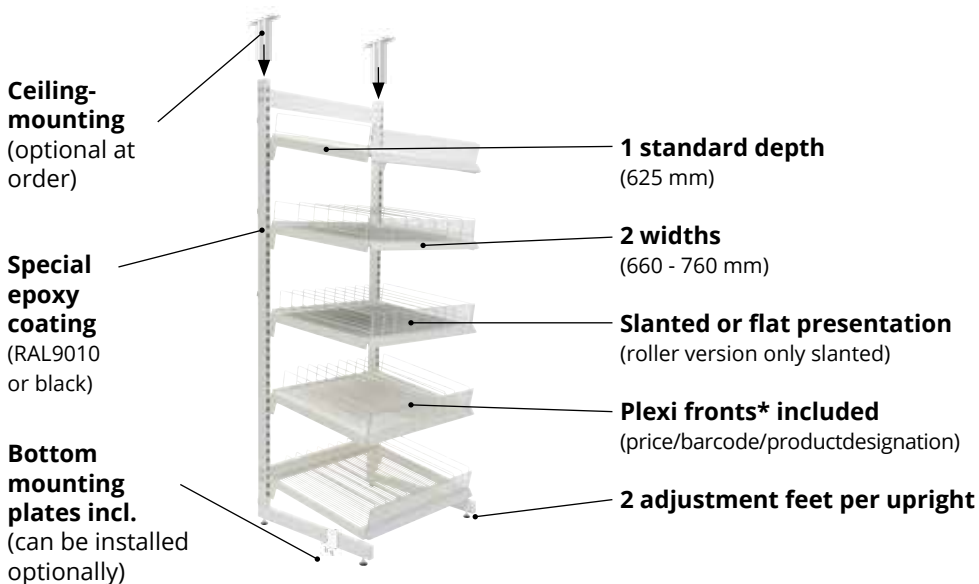

*: available in different heights



ASSEMBLY PLAN

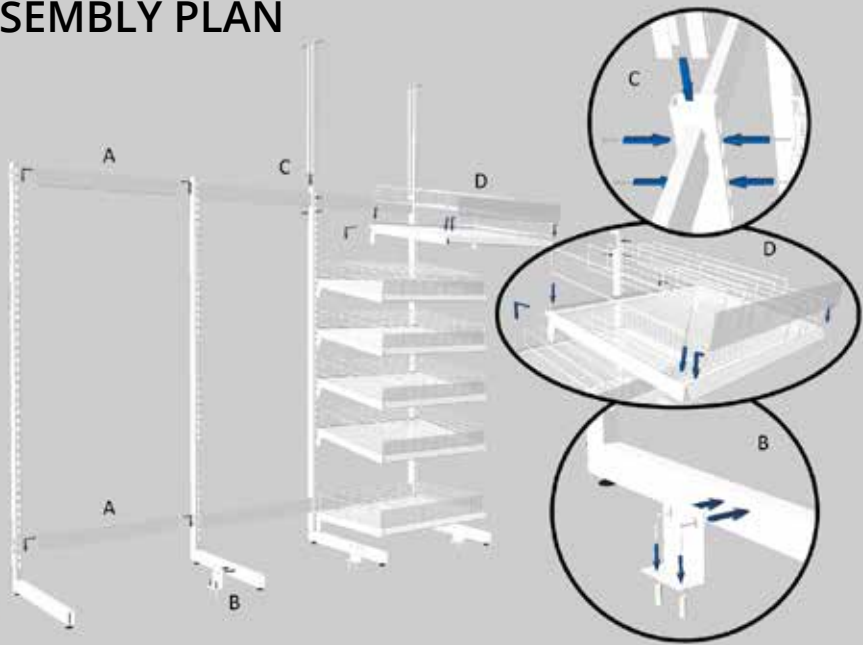

Contact us for further details

TECHNICAL SIZE DESIGNATION (W 660/760)

