

Eu Fish Treats manufacturer

- Stable Quality
- Bulk + White Label
- Export-ready documentation



Who is Fishok

Fishok is a European production platform for fish-based pet treats, helping B2B partners scale without risks in quality, documentation, and supply



- FDA approved / HACCP system
- European factory (Latvia, Northern Europe)
- 2,000 m² of own production facilities
- 40+ years of experience in the fish industry (founder)
- Manufacturing fish-based pet treats since 2015
- Exports to 22 countries



Who we work with

Bulk

Distributors

Wholesale companies

Bulk purchasing with in-house packaging

White Label

Brands

Product line owners

Finished product under their own brand

Small chains

Quick product selection

Minimum volumes

No production lead time

Custom product development

We help you
choose the most
cost-effective format



More than a supplier - your platform for stable growth



How Fishok eliminates these risks

Problems:	FishOk Control	The result
Inconsistent quality	Standardized processes and batch control	Predictable product
Delivery delays	Planning and transparent communication	Reliable supply
Lack of raw material transparency	Control of origin and incoming raw materials	Trust and stability
Import documentation issues	Ready export documentation package	Fast and secure import
Client volume growth	Scalable production capacity	Growth without changing supplier

Production philosophy



Raw materials



Processing



Drying



Cutting



Packaging



Quality control

Batch control

Protein
Fat quality
Moisture level
Bacteriological testing

Production facilities

100% in-house production
2,000 m² of owned production facilities
30–40 tons per month of stable output

Safety and control

Sterilization before packaging
Residual moisture control < 10%
UV lamps during the drying stage

Air-dried technology (gentle drying)

Preserves nutrients
Maintains product structure
Ensures stable texture and aroma



Natural dried fish treats help your pet:

- ✓ Improved digestion
- ✓ Skin and coat support
- ✓ Joint and ligament support
- ✓ Supports dental and gum health

External laboratory testing



Pure benefits of fish

No additives, no compromises:

- Grain-free
- Gluten-free
- No sugar or salt
- No artificial additives
- 100% natural product

Natural dried fish treats help your pet:

- Marine collagen
- Low fat content
- Omega-3 fatty acids
- High protein content
- Natural source of vitamin D



Raw materials and origin

Northern Europe as a quality standard



Direct contracts with processors

Raw materials from Iceland and Norway

No intermediary chain → Control over quality and timelines

We use different types of raw materials
– consciously and transparently:



- Vegetables – organic
- Cod – wild-caught only
- Berries – wild-collected (in recipes)
- Verified farms in Northern Europe



Zero waste
Maximum value

Full utilization of the fish
Efficiency without compromising quality
Primary raw materials and selected by-products are used

Assortment of dried fish treats



Formats, sizes, and packaging are adapted to the requirements of each client and market

Dried fish treats

Products made from whole raw materials without additives



Fish skin treats

Snack and chew formats (fish skin / cod skin)



Molded products

Cubes, sticks, twists, and other formats

Functional products

Treats focused on high protein and collagen content (high protein / high collagen)



01





















product code
CTC1

Cod Training Cubes - Bite-sized training rewards made from pure cod.

Perfect for daily training sessions, these small cubes are easy to chew, highly palatable, and naturally rich in lean protein and omega-3



Ingredient variants

 CTC01 spinach 	 CTC02 blueberry 	 CTC03 cranberry 	 CTC04 vegetables 	 CTC05 strawberry 
 CTC06 smoked sprats 	 CTC07 sprats 	 CTC08 wolffish 	 CTC09 salmon 	 CTC10 tuna 

Shape options

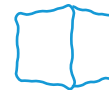

Length
Height
Width

2.5 cm
2.5 cm
2.5 cm

2.0 cm
2.0 cm
2.0 cm

1.5 cm
1.5 cm
1.5 cm

Analytical constituents:

Crude protein 70.0 % (min)
Crude fat 3.0 % (min)
Crude fibre 2.0 % (max)
Crude ash 18.0 % (max)
Moisture 14.0 % (max)



Bulk up to 40 kg



White label pack

Cod Jerky - Classic dried cod meat strips with a clean, crunchy bite.

A simple, high-protein reward made from pure cod fillet, gently dried to preserve natural flavor and nutrients.



Ingredient variants

 CJ01 spinach	 CJ02 blueberry	 CJ03 cranberry	 CJ04 vegetables	 CJ05 strawberry
 CJ06 smoked sprats	 CJ07 sprats	 CJ08 wolffish	 CJ09 salmon	 CJ10 tuna

Length
Height
Width

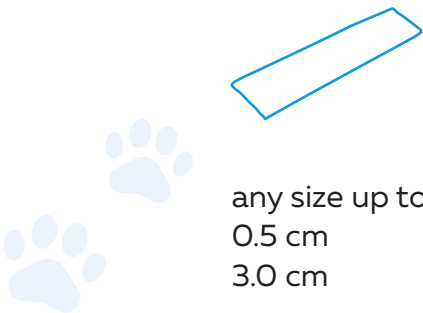

any size up to 20 cm
0.5 cm
3.0 cm

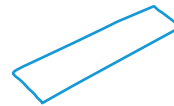

any size up to 20 cm
1.2 cm
2.3 cm



Analytical constituents:

- Crude protein 70.0 % (min)
- Crude fat 3.0 % (min)
- Crude fibre 2.0 % (max)
- Crude ash 18.0 % (max)
- Moisture 14.0 % (max)



Bulk up to 40 kg



White label pack

Cod Skin Jerky - Light, crispy strips made from pure cod skin



Naturally rich in collagen and omega-3, these airy, crunchy treats support skin, coat, and joint health.



Ingredient variants

 GSJ01 spinach 	 GSJ02 blueberry 	 GSJ03 cranberry 	 GSJ04 vegetables 	 GSJ05 strawberry 
 GSJ06 smoked sprats 	 GSJ07 sprats 	 GSJ08 wolffish 	 GSJ09 salmon 	 GSJ10 tuna 

Shape options



 Length any size up to 20 cm
 Height 0.5 cm
 Width 3.0 cm

 any size up to 20 cm
 1.2 cm
 2.3 cm



Analytical constituents:

Crude protein 80.0 % (min)
 Crude fat 3.0 % (min)
 Crude fibre 2.0 % (max)
 Crude ash 13.0 % (max)
 Moisture 14.0 % (max)



Bulk up to 40 kg



White label pack

Cod Dental Sticks - Firm, chewable sticks designed for daily dental care.

The dense texture helps reduce plaque and tartar while dogs enjoy a natural cod-based chew.



Ingredient variants

 CDS01 spinach 	 CDS02 blueberry 	 CDS03 cranberry 	 CDS04 vegetables 	 CDS05 strawberry 
 CDS06 smoked sprats 	 CDS07 sprats 	 CDS08 wolffish 	 CDS09 salmon 	 CDS10 tuna 

Shape options

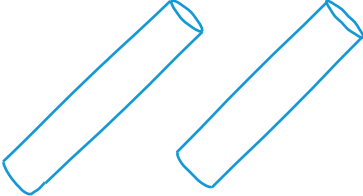
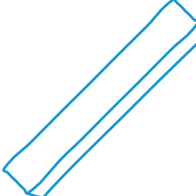
		
Length	any size up to 20 cm	any size
Height	...	1.5 cm
Width	...	1.5 cm
Diameter	0.6 – 1.1 cm	1.5 cm

Analytical constituents:

- Crude protein 70.0 % (min)
- Crude fat 3.0 % (min)
- Crude fibre 2.0 % (max)
- Crude ash 18.0 % (max)
- Moisture 14.0 % (max)



Bulk up to 40 kg



White label pack

Cod Skin Medallions - Round, fish or bone shape crunchy cod skin bites with a satisfying snap.

A natural source of protein, collagen, and omega-3, perfect as a functional reward or light chew.



Ingredient variants

 CSM01 spinach	 CSM02 blueberry	 CSM03 cranberry	 CSM04 vegetables	 CSM05 strawberry
 CSM06 smoked sprats	 CSM07 sprats	 CSM08 wolffish	 CSM09 tuna	

Shape options

Fish shape

Bone shape

Medallion Shape

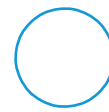

Length

5.4 cm

5.8 cm

1.0\1.2\1.5 cm

Height

0.7 cm

0.7 cm

0.4 cm

Width

2.5 cm

2.85 cm

Round shape

Analytical constituents:

Crude protein 80.0 % (min)

Crude fat 3.0 % (min)

Crude fibre 2.0 % (max)

Crude ash 13.0 % (max)

Moisture 14.0 % (max)



Bulk up to 40 kg



White label pack

Cod medallions – Round, fish or bone shape cod meat pieces.

Pure dried cod portions that deliver clean protein and authentic fish flavor in every bite.



Ingredient variants

 CM01 spinach	 CM02 blueberry	 CM03 cranberry	 CM04 vegetables	 CM05 strawberry
 CM06 smoked sprats	 CM07 sprats	 CM08 wolffish	 CM09 tuna	

Shape options

Fish shape

Bone shape

Medallion Shape

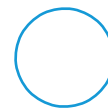

Length

Height

Width



5.4 cm

0.7 cm

2.5 cm

5.8 cm

0.7 cm

2.85 cm

1.0\1.2\1.5 cm

0.4 cm

Round shape

Analytical constituents:

Crude protein 70.0 % (min)

Crude fat 3.0 % (min)

Crude fibre 2.0 % (max)

Crude ash 18.0 % (max)

Moisture 14.0 % (max)



Bulk up to 40 kg



White label pack

Cod Skin Flats - Flat, chewy cod skin pieces for longer chewing sessions.

Hand-cut from natural cod skin, offering a durable texture that keeps dogs engaged

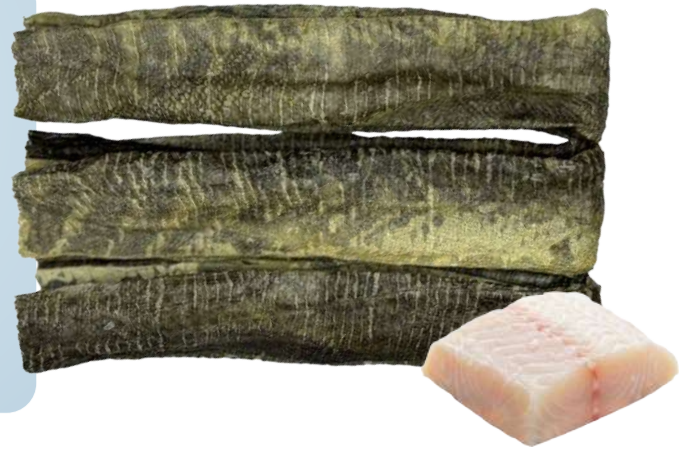

Ingredient variants



CSF01
spinach



CSF02
vegetables



CSF03
blueberry



CSF04
strawberry



Shape options



Length



19 – 21 cm

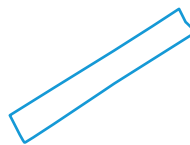

15 – 17 cm

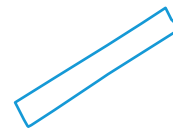

10 – 13 cm



Analytical constituents:

Crude protein 80.0 % (min)

Crude fat 3.0 % (min)

Crude fibre 1.0 % (max)

Crude ash 10.0 % (max)

Moisture 14.0 % (max)



Bulk up to 40 kg



White label pack

08

HANDMADE

product code
CST8

Cod Skin Twists - Twisted cod skin chews with an elastic, long-lasting texture.

The spiral shape increases chewing time while delivering natural collagen and omega-3



Ingredient variants



CST01
spinach



CST02
vegetables



CST03
blueberry



CST04
strawberry



Shape options

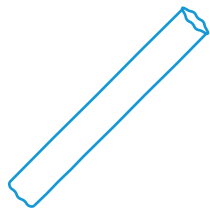

Length
Diameter

20 cm
1.0 - 1.5 cm



Analytical constituents:

Crude protein 80.0 % (min)
Crude fat 3.0 % (min)
Crude fibre 1.0 % (max)
Crude ash 10.0 % (max)
Moisture 14.0 % (max)



Bulk up to 40 kg



White label pack

09

product code
WSF10

Cod Skin Fingers - Long, hand-wrapped cod skin chews.

Layered construction creates a firm, satisfying bite that lasts longer than standard skin strips.



Shape options



Size



Can be made in any size



from 2 cm

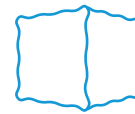

to 3 cm



Analytical constituents:

Crude protein 80.0 % (min)

Crude fat 3.0 % (min)

Crude fibre 1.0 % (max)

Crude ash 10.0 % (max)

Moisture 14.0 % (max)



Bulk up to 40 kg



White label pack

Wolffish skin Flats - Dense, chewy flats made from tough wolffish skin.

A robust, long-lasting chew with a distinctive texture for experienced chewers.



Shape options

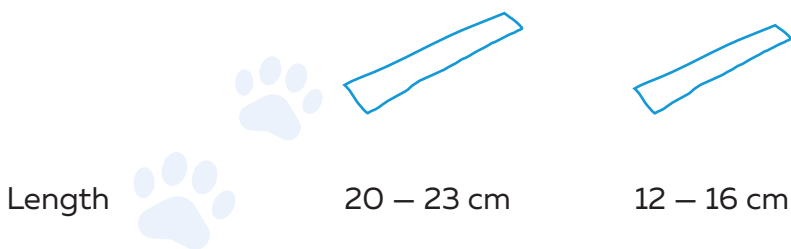

Analytical constituents:

Crude protein 85.0 % (min)
Crude fat 4.0 % (min)
Crude fibre 0.5 % (max)
Crude ash 7.0 % (max)
Moisture 14.0 % (max)



Bulk up to 40 kg



White label pack

PACKAGING OPTIONS



Stand-up pouches
(with zip lock / euro slot)



Pouches with single-color
or full-color printing



Paper pouches with window



Cardboard tubes



Plastic pouches



Plastic jars



Your brand – your positioning
We adapt packaging design to your market

WHITE LABEL YOUR BRAND – OUR PRODUCTION CAPACITY



Launch your own premium line of fish-based treat
– without building a factory.

We produce – you scale

Concept → Recipe → Packaging → Production → Delivery

Why choose white label with Fishok?

Natural dried fish treats help your business:

- Fast product development
- Premium fish raw materials
- Compliance with EU standards
- Wide range of packaging formats
- Full production cycle within the EU
- Flexible MOQ (minimum order quantity)
- Support with specifications and documentation

Customization options

- Multilingual layout
- Matte or glossy lamination
- Sticker labeling or full-color printing
- Full design adaptation to your brand
- Packaging options with transparent window
- Barcodes and compliance with regulatory requirements

We select the product, format,
and documentation for your market

Fishok

Needs assessment

Product and format selection

Samples / factory visit

MOQ and lead times

Market-specific documentation

Production and quality control

Logistics and export

—

 fishok.lv

 fishok@fishok.lv



fishok.lv

