

TWINSON DECKING SYSTEMS

SIMPLY WONDERFUL
COMPOSITE DECKING!

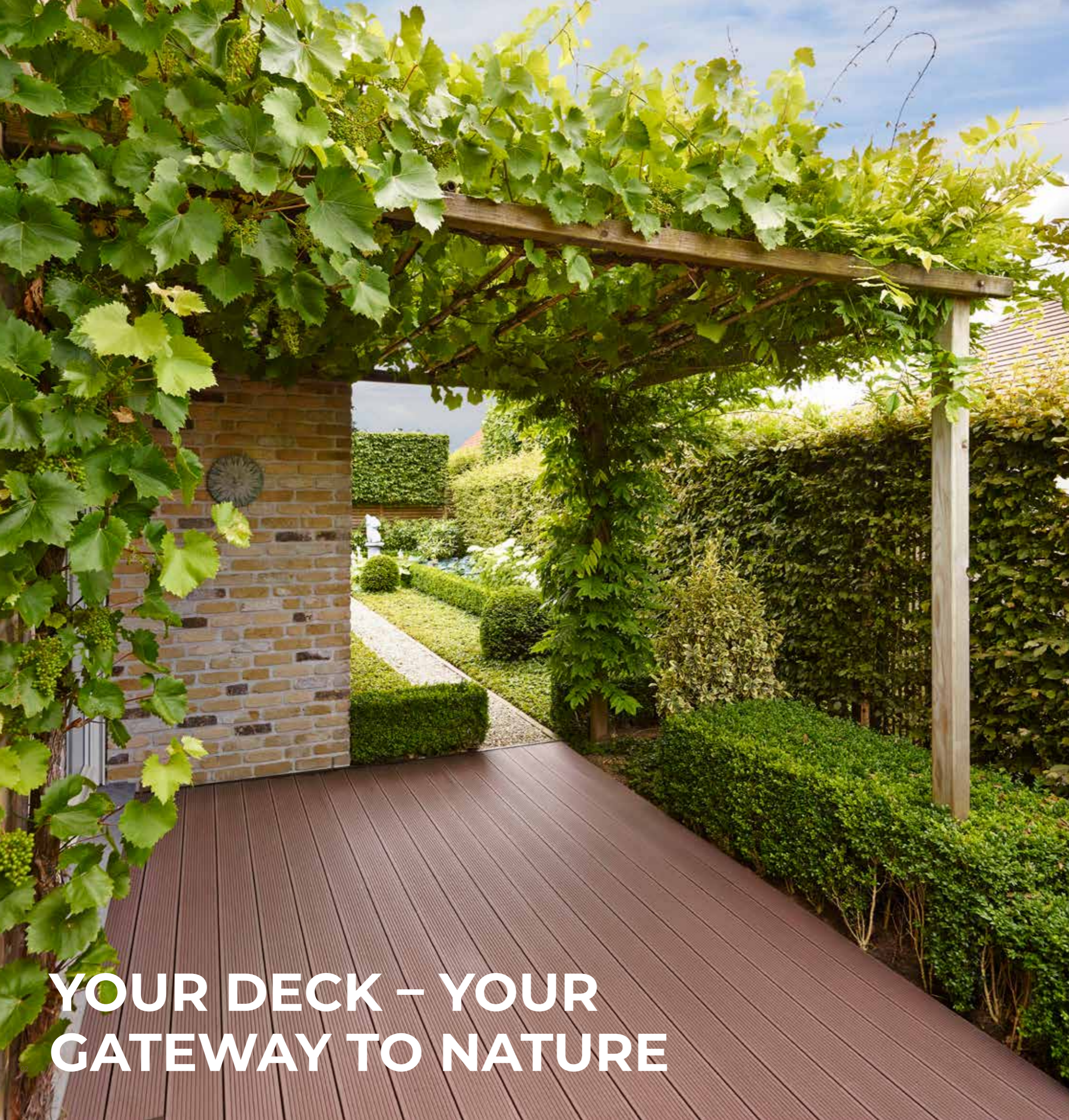

A BRAND OF **deceuninck**



YOUR DECK – YOUR GATEWAY TO NATURE

Bridge your home into nature with a deck you love. When the sun arrives, kick off your shoes and breathe the open air with loved ones, in joyful solitude, or perhaps while you work.

Twinson decking can transform your terrace, balcony, garden path, or pool area into a robust, eco-friendly, and easily-maintained living space. Deceuninck solutions provide you with a refined combination of aesthetics, high-quality, and environmental awareness.

- 05 Overview and Advantages of Twinson Decking Boards
- 07 Majestic Massive Pro With 360° Coating
- 09 Character Massive
- 11 Essential XL
- 13 Essential Terrace
- 14 Which Twinson Decking is Best Suited to Your Needs?
- 15 Maintenance and Cleaning
- 17 Screwless Twinson Click Installation
- 18 Standard Installation and Accessories



TWINSON, THE IDEAL ALTERNATIVE TO WOODEN DECKING

THE PERFECT BALANCE BETWEEN TECHNOLOGY AND NATURE

Twinson decking boards are made from PEFC-certified wood and recycled PVC, combining the advantages of both materials into an innovative composite featuring the natural and warm appearance of wood and the durability and longevity of PVC.

The decking boards are not only high-quality, they are also impressively environmentally friendly. The boards feature an eco-core, contain recycled PVC, and are fully recyclable.

Release Your Creativity

Twinson boards can be cut into every shape you need. Available in various colours inspired by nature, Twinson decking boards are perfectly suited to the environment that surrounds them. Our decking boards can enhance any architecture and landscape.

Four Types Of Decking Boards To Meet Your Needs



Twinson Majestic Massive Pro



Twinson Character Massive



Twinson Essential XL

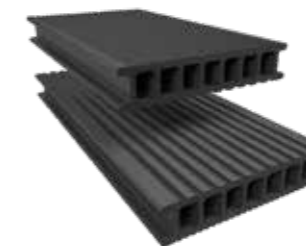

Twinson Essential Terrace



A Unique Material Solution, Mix Of Wood And PVC



Natural and warm appearance



Low-maintenance



PEFC™ certified



100% recyclable



Robust and durable



No splitting



Insect-resistant



Chlorine-resistant (ideal for poolsides)



Non-slip, even when wet



Barefoot comfort (no splinters)



ELEGANT AND DURABLE DECKING



MAJESTIC MASSIVE PRO

P 9369

The solid decking board with a 360° coating
 Featuring an authentic wood embossing and unique colour palette, the Majestic Massive Pro meets the highest requirements in terms of aesthetics and quality. With its 360-degree coating, this low-maintenance, robust decking board has an amazing colour stability and a high stain resistance. Whether for your balcony, terrace or winter garden, consider all of your needs solved with the Majestic Massive Pro.



270
SMOKED OAK



271
ANTIQUE OAK

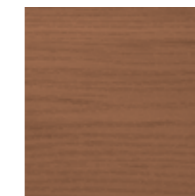

517
NATURAL TEAK



519
COUNTRY OAK



520
MOUNTAIN OAK

SPECIFICATIONS

- Board width: 140 mm
- Board thickness: 20 mm
- No visible screws
- Easy to install, assembled with a clip system
- Warranty conditions are available on the website or at your local dealer.

COMPATIBLE WITH THE TWINSON CLICK INSTALLATION SYSTEM ON PAGES 16-17

360°

Extremely robust decking board covered with a 360° protective coating



High fire and heat resistance – B_{Roof} (t1) certification for flat roofs*



Two different sides allows you to choose between two designs: wood-like appearance or finely grooved appearance



Total structural height starting from 36 mm (ideal for balconies and decks)



High UV resistance**



High resistance to stains and impacts



Non-slip, even when wet



Limited humidity absorption (2 mm/m expansion)



Ideal for public places



High load resistance



Full decking board enables varied shapes

* Available upon request. Specific installation conditions apply.
 ** Under our standard maintenance & cleaning conditions



**WARM AND
NATURAL APPEAL**



CHARACTER MASSIVE

P 9360

The solid decking board with a natural surface
 With its natural colour range and brushed surface, the Character Massive offers a warm and inviting look and feel, resembling wood. Its durable properties makes it suitable for private- as well as public applications. Thanks to the Character Massive's solid shape, even elaborately curved decking designs are possible.



The colour samples are reproductions and may vary from the final product. The large surfaces represent the natural colour which the Twinson boards will have over time.

SPECIFICATIONS

- Board width: 140 mm
- Board thickness: 20 mm
- No visible screws
- Easy to install, assembled with a clip system
- Warranty conditions are available on the website or at your local dealer.

COMPATIBLE WITH THE TWINSON CLICK INSTALLATION SYSTEM ON PAGES 16-17



High fire and heat resistance – B_{Roof} (t1)* certification for flat roofs



Two different sides allows you to choose between two designs: wood-like appearance or finely grooved appearance



Total structural height starting from 36 mm (ideal for balconies and decks)



The natural and warm look of wood with the advantages of PVC



Non-slip, even when wet



Limited humidity absorption (2 mm/m expansion)



Ideal for public places



High load resistance



Full decking board enables varied shapes

* Available upon request. Specific installation conditions apply.



EXTRA WIDE DESIGN TREND



ESSENTIAL XL

P 9335

The extra-wide decking board with hollow chambers
The Essential XL is an oversized, 7-chambered composite hollow decking board with distinctive decorative grooves on one side. Ideal for larger areas such as terraces, pathways, and gardens destined for private use, the Essential XL provides an exemplary wooden floor appearance with its broad width.



502
LIQUORICE BLACK



503
HAZELNUT BROWN



504
BARK BROWN

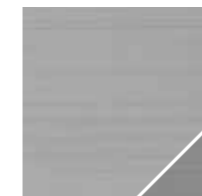

509
PEBBLE GREY



510
SLATE GREY



522
NUT BEIGE

The colour samples are reproductions and may vary from the final product. The large surfaces represent the natural colour which the Twinson boards will have over time.

SPECIFICATIONS

- Board width: 180 mm
- Board thickness: 20 mm
- No visible screws
- Easy to install, assembled with a clip system
- Warranty conditions are available on the website or at your local dealer



High fire and heat resistance – B_{Roof} (t1)*
certification for flat roofs



Particularly suitable for straight decks
with square or rectangular shapes



The natural and warm look of wood
with the advantages of PVC



Total structural height
starting from 36 mm



Extended width of 180mm,
for an XL design



Catch the upcoming trend for large
surface tile decks with Essential XL,
providing broad coverage and
a refreshing aesthetic

* Available upon request. Specific installation conditions apply.

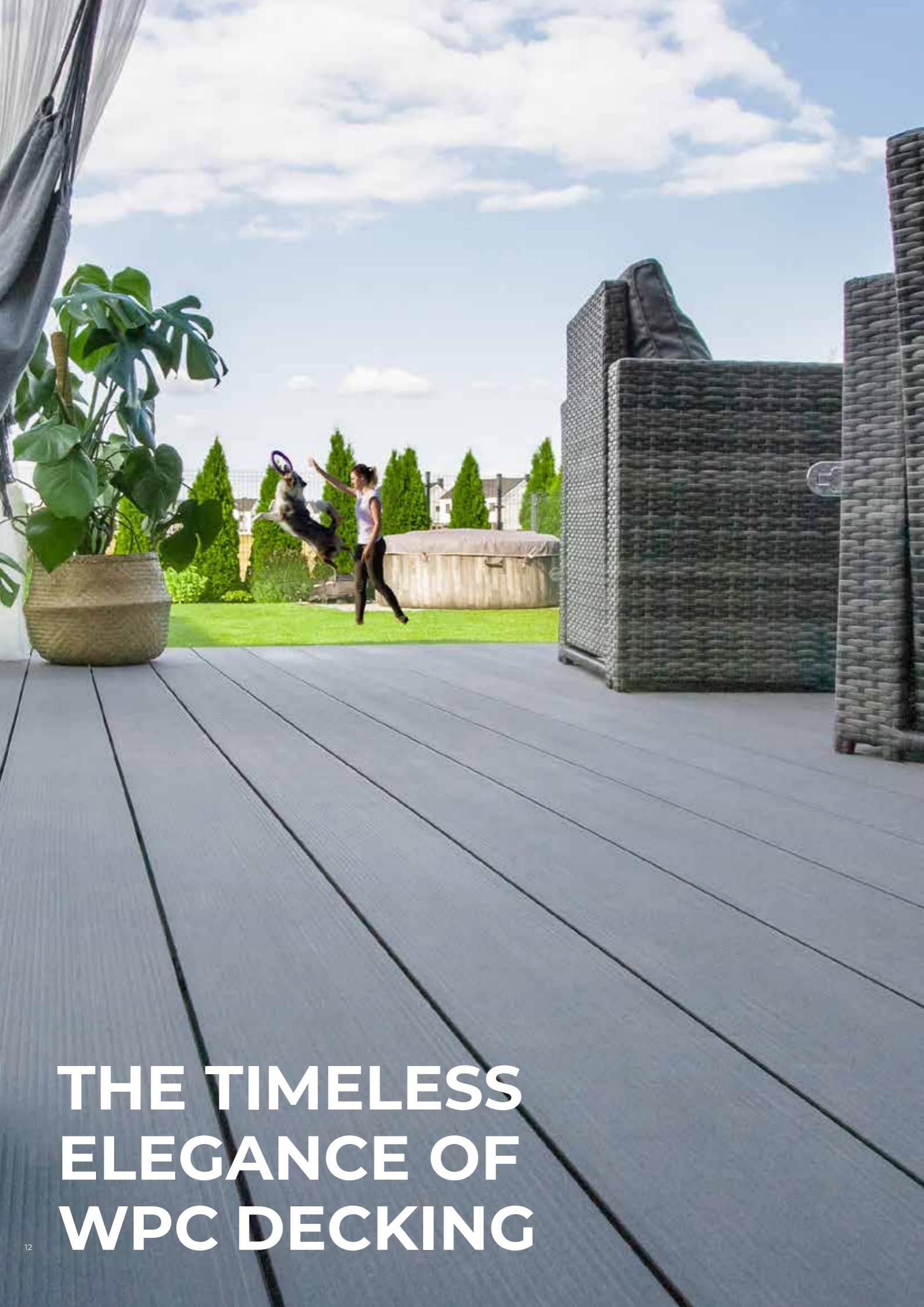

THE TIMELESS ELEGANCE OF WPC DECKING

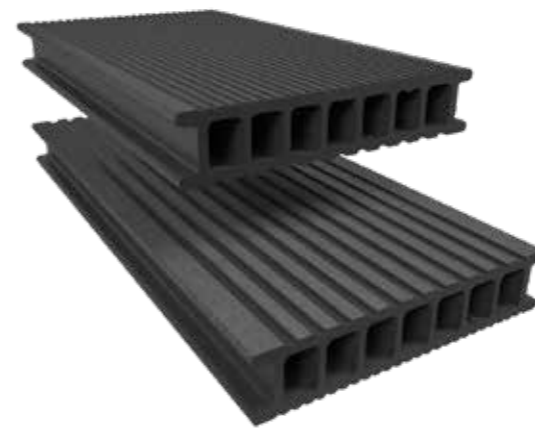

ESSENTIAL TERRACE

P 9555

The classic chambered decking board

The Essential Terrace decking boards are perfectly suited for private applications such as garden paths, patios and backyard decks. With seven defined chambers and two differently grooved sides, the Essential Terrace hollow decking boards emphasize clean-cut design at its finest.



The colour samples are reproductions and may vary from the final product. The large surfaces represent the natural colour which the Twinson boards will have over time.

SPECIFICATIONS

- Board width: 140 mm
- Board thickness: 28 mm
- No visible screws
- Easy to install, assembled with a clip system
- Warranty conditions are available on the website or at your local dealer.



High fire and heat resistance – B_{roof} (t1)* certification for flat roofs



Two different sides: fine grooves or wide grooves



Particularly suitable for straight terraces with square or rectangular shapes.



The natural and warm look of wood with the advantages of PVC



Total structural height starting from 44 mm

* Available upon request. Specific installation conditions apply.

CHOOSE THE DECK WHICH IS BEST SUITED TO YOUR NEEDS

The Twinson decking board range has been specially designed to meet all your needs. Each decking board has its own specifications and features, providing an impeccable solution for all types of installations and budgets.



Board width	140 mm	140 mm	180 mm	140 mm
Board thickness	20 mm	20 mm	20 mm	28 mm
Centre distance between support beams	50 mm	50 mm	40 mm	50 mm
Number of colours	5	6	6	6
Anti-slip class C	✓	✓	✓	✓
No splinters	✓	✓	✓	✓
Barefoot comfort (soft touch)	✓	✓	✓	✓
Double-sided design	✓	✓		✓
Suited for poolsides	✓	✓	✓	✓
Installation on tile with substructures	✓	✓	✓	✓
Floating installation in frame construction	✓	✓	✓	✓
High fire resistance (B_{Roof} (t1))	✓	✓	✓	✓
Suited for public places	✓	✓		
Installation with Twinson Click system (p. 16-17)	✓	✓		
Circled deck	✓	✓		
Grooved wood effect	✓			
Stain-resistant outer layer	✓			
High UV resistance*	✓			

* Under our standard maintenance & cleaning conditions

ENJOY YOUR TWINSON DECK FOR DECADES

Dust and pollen stains, food and drink spills – decks are constantly exposed to dirt and grime. These cleaning tips will have you enjoying your deck for many years.

CHARACTER MASSIVE - ESSENTIAL XL - ESSENTIAL TERRACE



Cleaning Your Deck for the First Time

Immediately after installation, clean your deck thoroughly using a soap solution and a soft brush (no metal brushes!). Always move the brush in the direction of the decking boards' grooves. Then rinse the area with clean water using a hose or high-pressure cleaner, in the direction of the grooves.



Colour Variation, a Natural Patina Over Time

Twinson contains wood fibres which are likely to create variations in colour and appearance. As soon as the product is exposed to sun and rain, these fibres undergo a natural ageing process and their colours are modified. The final colour stabilises after a few months. Before the installation, decking boards must therefore be mixed to obtain a more natural effect.

MAJESTIC MASSIVE PRO



Easy Maintenance

After cleaning your deck for the first time after installation, make sure to regularly sweep your deck, removing dirt, leaves, and any other surface debris. Grime can easily be removed from between decking boards using a putty knife. Thorough cleaning should ideally take place three times per year, using a high-pressure cleaner in the direction of the grooves. However, depending on the environment, more frequent cleaning is recommended. In shaded or damp places especially, moss or fungi can form on the decking boards. These can be removed with a diluted chlorine solution.



Removing Water Marks and Stains

Water marks may appear as stains in covered or semi-covered areas. This is caused by lignin, a natural component of wood, when exposed to rain. These marks can usually be removed with plenty of hot water. Special detergents are also available, such as Twinson Terrace Cleaner. For oil, lacquer or silicon stains, use our Twinson O'Clean solution.



Regular Care

Make sure to regularly sweep your deck, removing dirt, leaves, and any other surface debris. Grime can easily be removed from between decking boards using a putty knife. We advise cleaning the deck three times a year using a high-pressure cleaner in the direction of the grooves. However, depending on the environment, more frequent cleaning is recommended. In shaded or damp places especially, moss or fungi can form on the decking boards. In this case, we recommend that you clean the deck immediately with a diluted chlorine solution.





rubber pad



triangular connection plate



lightweight aluminium profiles available in 30 and 50 mm



height-adjustable deck supports and extension pieces



height-adjustable deck supports and triangular connection plate

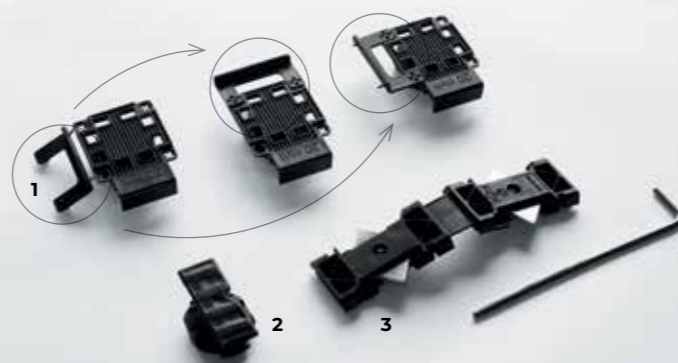

1: multi-adjustable vertical clip, 2: horizontal rotating clip, 3: flexible corner clip connection plate

SCREWLESS, EASY TO INSTALL SUBCONSTRUCTION FOR MASSIVE BOARDS

The Twinson Click system's ease of use, ergonomic design, time-saving features, and durability make it above and beyond the best decking solution for the professional installer.

Building a Twinson deck is simple and its components are well-designed. The triangular connection plate can be easily clicked into the aluminium substructure. Any height differences or uneven surfaces are simply leveled out by the height-adjustable deck supports and extension pieces. The screwlessly fixated Twinson decking boards are the perfect finish to the modular Twinson Click system.



Time-saving

Thanks to the clickable system, the average Twinson Click deck can be installed two-and-a-half times faster than a traditional deck using timber and screws. The more complex the shape of the deck, the more time saved!



Ergonomic

The ease of assembly makes installation much more efficient and easier than the classic method using screws.



Durable

Unlike timber, the aluminium substructure is stable, durable and won't distort. The Twinson decking boards have also demonstrated their high level of durability over the years.



Flexible

Twinson Click offers customised solutions for every customer, featuring a wide range of Twinson decking boards in a multitude of finishes and natural colours. In addition, the click system is able to take on any shape of deck.

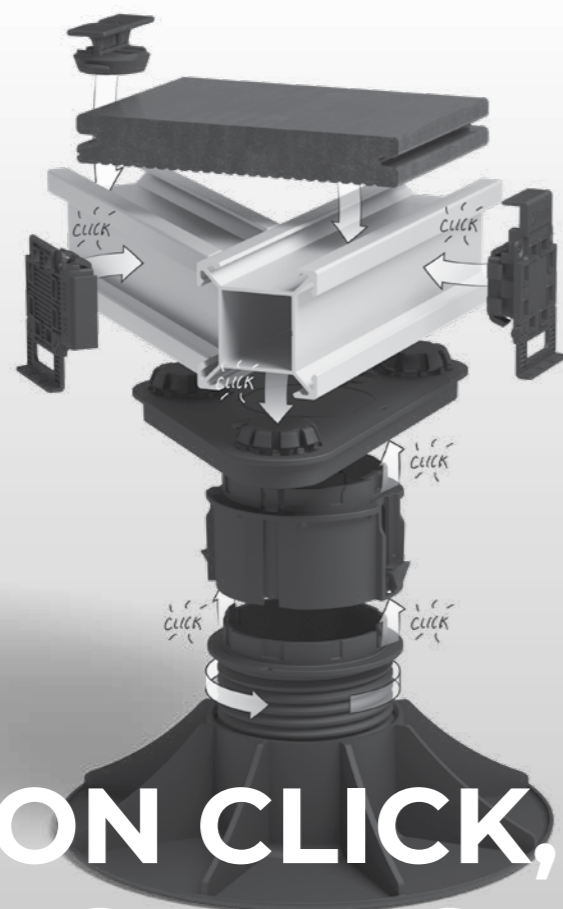

TWINSON CLICK, SIMPLY GENIUS



STANDARD INSTALLATION SYSTEM

You'll be won over by how easy it is to install all Twinson decking systems. An easy and secure installation is guaranteed, for both hollow and massive decking boards.



Fixed or Floating Installation

Follow the simple step-by-step instructions:

- Install the Twinson aluminium substructure system which is adapted to your needs.
- Adapt the height if necessary with adjustable deck supports. Rubber pads may be used for limited assembly heights.
- The aluminium substructure is placed on the deck supports.
- Cut the decking boards to the appropriate dimensions.
- Secure them to the substructure beams using the innovative and invisible clip system.
- Each decking board is locked in the centre with a single screw in the fixating clip.
- Cover the edges of the deck if necessary, using finishing accessories of your choice.

THE RIGHT ACCESSORIES FOR ALL SYSTEMS

The quality of a deck's substructure is essential as it guarantees its stability, its protection against dampness and consequently, its lifetime. Our complete installation system proposes a wide range of accessories which enable solutions for the most diverse requirements and the most unusual decking shapes and sizes.

Aluminium Support Beams For All Situations

Whatever the building situation may be, Twinson decking boards can be installed with aluminium support beams.



P 9522
Aluminium profile
Partial support fixed installation or total support floating installation
Max. support distance 500 mm
50x50 mm



P 9523
Aluminium profile
Total support fixed installation
50x16 mm



P 9524
Aluminium profile
Total support floating installation
Max. support distance 1,200 mm
50x80 mm



P 9530
Aluminium profile
Total support fixed installation
50x30 mm

Substructure Connectors



Corner connector kit P 9495 for floating assembly with P 9524



Divisible corner connector kit P 9468 for floating assembly with P 9522

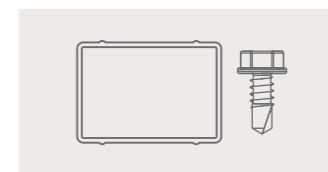

Straight connector P 9510 + screw P 9515 for P 9522

Assembly Clips: Simple, Quick to Install and Invisible

Metal or high-quality plastic



Standard assembly clip kit P 9469 for 20 mm decking boards, suitable for all aluminium substructure beams



Multi-angle assembly clip P 9365 + screw P 9467 for 20 mm decking boards, suitable for all aluminium substructure beams



Assembly clip kit P 9477 for 20 mm decking boards, suitable for wooden supports



Standard assembly clip kit P 9486 for 28 mm decking boards, suitable for all aluminium substructure beams



Standard assembly clip kit P 9483 for 28 mm decking boards, suitable for wooden supports

End Profiles for a Perfect Finish

Available in Twinson or anodised aluminium



Twinson end profile P 9556 (Character Massive only)



Anodised aluminium F-shaped end profile P 9363

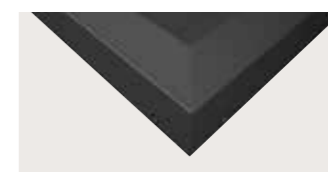

Anodised aluminium L-shaped end profile P 9518

Deck Supports for the Right Height

Stabilise ground-level differences from 35 to 215 mm

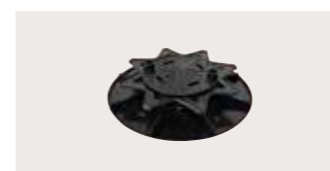

Height-adjustable deck support P 9430
35 to 55 mm pivoting base

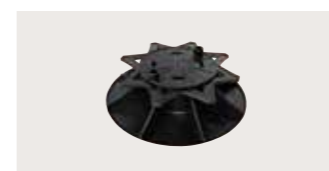

Height-adjustable deck support P 9431
55 to 95 mm pivoting base



Height adaptor P 9429 for deck support P 9431
95 to 215 mm

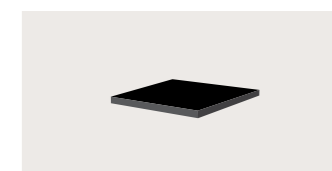

Rubber pad P 9326
90x90 mm
Thickness 8 mm

Multifunctional Ventilation Profiles



Ensure proper deck ventilation and water drainage
Available in three colours: silver, black and brown

- Two profiles for one board width
- Installed with the same fixating clip as the boards
- Ventilation profile P 9440 for 20 mm decking boards
- Ventilation profile P 9442 for 28 mm decking boards



BUILDING A SUSTAINABLE HOME

Through innovative designs and production processes
we deliver the most sustainable window, door and building solutions
for today's and tomorrow's customers.

deceuninck

Deceuninck nv • Bruggesteeweg 360 • B-8830 Hooglede-Gits
T +32 (0)51 239 211 • info@deceuninck.com • www.deceuninck.com

YOUR DECEUNINCK PARTNER

The certified Deceuninck partners are part of a network of distributors who take pride in delivering outstanding work. This network ensures a correct installation and high-quality service, without a doubt an added value for your Deceuninck product.

PUT YOUR STAMP HERE