

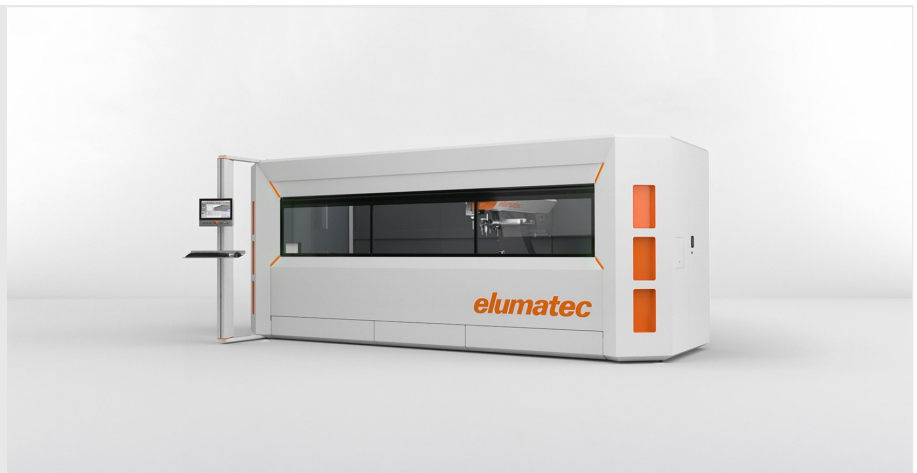

SBZ118

Machining Centres



The SBZ 118, a 3-axis profile machining centre with optional 5-sided machining that's easy to use and has a minimal footprint, expands the elumatec range of entry-level products for automated CNC machining of aluminium, PVC and thin-walled steel profiles. With its machining length of three metres, this versatile and powerful model is the most compact CNC machine in the current elumatec range.

The SBZ 118 offers full functionality for milling, drilling and notching in a small space. It was developed for machining up to five sides with an optional angle head and end milling machine, depending on the individual configuration. The proven inclined bed technology and the on-board 5-fold tool changer make it easy to use.

The SBZ 118 is made particularly attractive by individually configurable optional equipment, including up to two on-board angle head changers, expansion to up to six clamps, an additional length stop with overlength machining and a barcode scanner. A side service door facilitates set-up and maintenance, and the new front visor enables ergonomic and above all safe operation – even for tall people. Plus, the SBZ 118 is eluCloud ready to meet the requirements of Industry 4.0.

- Designed for economical and efficient machining of aluminium, PVC and thin-walled steel profiles
- All operations, such as routing, drilling, notching and tapping, are performed while the profile bar is stationary to protect the profile surfaces
- Better machining results thanks to intelligent control technology
- Fast positioning of the machining unit with up to 60 m/min thanks to dynamic servo drives
- Tapping without compensation chuck
- Automatic clamp recognition and clamp positioning
- Automatic on-board tool changer with five tool tray positions (without tools)
- State-of-the-art 3-axis controller
- Ergonomic and stable operation thanks to the advanced inclined bed
- Automatic clamp recognition and positioning prevents collisions
- Power torque routing motor with enclosed speed control for short spindle start-up and braking times.
- Low power consumption thanks to intelligent control technology
- DC link coupling in the axis drives for greater energy efficiency
- Uninterruptible power supply (UPS)
- Windows operating system
- 15.6" panel PC, i3 processor, USB ports and network connection
- Simple, stress-free program entry with eluCam on the operating panel, even during operation
- eluCloud ready
- Remote online maintenance



Machine configuration

- Air-cooled 5 kW, S1 routing spindle
- Protective cabin with side service door
- Four horizontal, pneumatic material clamping units
- A material stop on the left
- HSK-F63 tool holder
- Minimum-volume lubrication system
- High-performance cutting fluid

Options

- 1 or 2 optional on-board tool changers for rotating angle heads for 5-sided machining
- HSK-F63 rotating angle head for two tools
- Tools and tool holders with process data
- Barcode scanner
- Length measurement on both sides
- Double clamping and other accessories on request
- 18.5" panel PC, i5 processor
- 21.6" panel PC, i7 processor
- Green Line cooling unit for the control cabinet with reduced energy consumption
- Four clamps as standard. Can be equipped with up to six clamps
- Material reference stop (right) for positioning workpieces with overlength machining
- CE version as standard, UL version optional



Tool magazines

Short changeover times thanks to the on-board tool magazine for five tools for machining from above. Two optional magazines for two rotating angle heads (with two tools) allow the machine to be expanded for 5-sided machining.

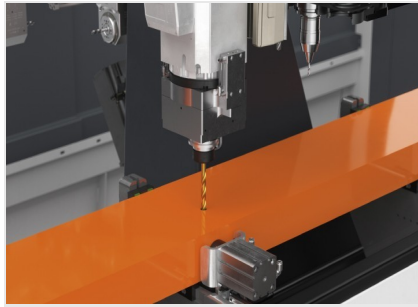

Inclined bed and large working area

The machining unit (X-Y-Z axis) moves on a cleverly designed inclined machine bed, offering excellent ergonomics. Cleaning is much easier thanks to the 45-degree inclination, which makes the chips fall downwards, and the operator can stand close to the machine table when inserting the profile to make their work easier. The machine also combines a large working area with optimum machining stability in a compact space.



Material stop, automatic clamps, longer profiles

Optimum machining results on profiles up to 3,000 millimetres long thanks to the material stop on the left and four compact clamps made from vibration-damping cast steel in a slim yet highly rigid design. Individual clamping pieces and support blocks are easy to add and use, while linear guides allow precise automatic adjustment of the clamping system. The SBZ 118/20 can be equipped with two additional clamps and a material stop on the right. Material feed-throughs in the protective cabin and a variable length stop also allow profiles longer than 3 m to be machined.



HMI and machine control

The SBZ 118/20 is the quick way to get started with CNC machining: it runs on Windows, is controlled via the proven SBZ 1xx series ECI user interface and uses the latest hardware and controller technology. A wide range of metal construction programs can be controlled via eluCad and the full functionality of a CAD-CAM module from the industrial sector is available. Like the larger CNC centres from elumatec, the compact SBZ 118/20 is also eluCloud ready to meet the requirements of Industry 4.0: machine and process data can be recorded and optionally evaluated, allowing you to analyse and optimise operation and to send a real-time finished parts message to the production control computer or the ERP.

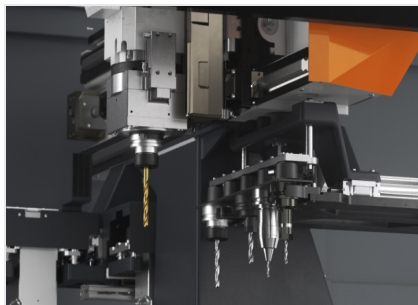

Machining unit

Fast machining changeovers and flexible 5-sided machining: the machining unit has a 5.0 kW routing spindle and optional HSK-F63 rotating angle head for two tools, an automatic tool changer and optional angle heads.

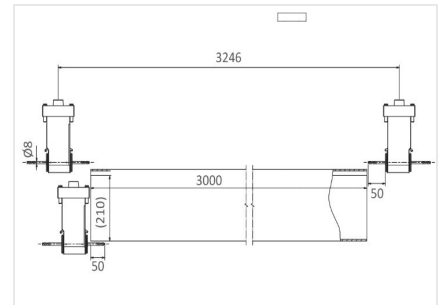

Machining area, X-axis

Profile machining from above and from the end (optional)



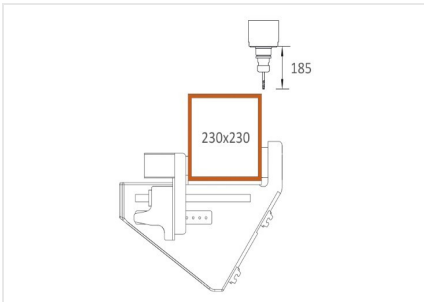

Machining area, Y and Z-axes (1)

Profile machining from above

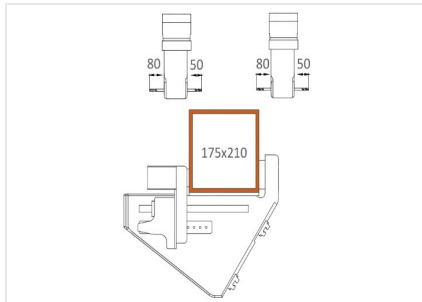

Machining area, Y and Z-axes (2)

Profile machining from the front and from behind (optional)

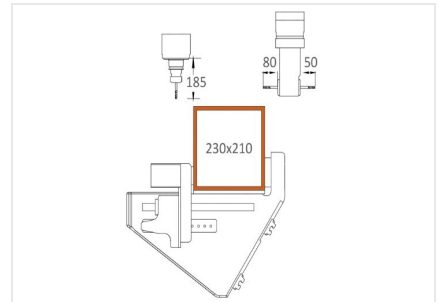

Machining area, Y and Z-axes (3)

Profile machining from above and from behind (optional)





SBZ 118 / MACHINING CENTRES

Axis

X-axis traverse path	3,246 mm, Vmax. 60 m/min.
Max. machining length	3.000 mm
Y-axis traverse path	942 mm, Vmax. 30 m/min.
Z-axis traverse path	366 mm, Vmax. 30 m/min.
Positioning accuracy	+/- 0.1 mm
Direction of machining	5 (above, behind, front, left, right)

Spindle And Tools

Routing spindle power	5 kW, S1 with feedback (air-cooled)
Tool holder	HSK-F63
Tool changing	automatic
Tool tray positions in the automatic magazine	5
Angle head	max. 2 pieces with up to 2 tools per head
Disc milling cutter diameter	100 mm
Tool length	max. 185 mm from HSK clamping surface
Clamp positioning	automatic
Routing spindle speed	max. 24,000 rpm

Dimensions

Height (with retracted Z-axis without optional roof)	2,270 mm
Depth	1,955 mm
Weight	approx. 3,067 kg
Total length (without overlength machining)	5,520 mm

Software And Connections

Software	eluCam
Compressed air supply	> 7 bar
CE power supply (UL optional)	400 V, 3~, 50 Hz, 25 A
Air consumption per minute	approx. 185 l with spraying (7 bar)

Included ● Available ○