



THERMOPLASTIC TUBING AND HOSES
SINCE 1961



REFRIGERAZIONE / REFRIGERATION







Tubi termoplastici e raccordi per la **refrigerazione**
*Thermoplastic Hoses and Fittings for **Refrigeration Systems***

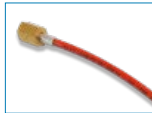

THERMOPLASTIC TUBING AND HOSES
MADE IN ITALY

Indice / Index

Azienda / Company	04	
Qualità / <i>Quality</i>	06	
Imballi / <i>Packaging</i>	07	
Area assemblaggio / <i>Assembly Area</i>	07	
Etichettatura e tracciabilità / <i>Labelling and Traceability</i>	07	
	Le soluzioni ZEC per la refrigerazione / ZEC Solutions for Refrigeration Systems	08
	Tubi termoplastici e raccordi per la refrigerazione / Thermoplastic Hoses and Fittings for Refrigeration Systems	09
Tubi capillari FR5T / FR5T Capillary Hoses	10	
Caratteristiche tecniche / <i>Technical Features</i>	11	
Raccordi per tubo capillare FR5T DN2 / FR5T DN2 Capillary Hose Fittings	12	
Istruzioni di assemblaggio FR5T DN2 / <i>Assembly Instructions FR5 DN2</i>	13	
Raccordi per tubo capillare FR5T DN4 / FR5T DN4 Capillary Hose Fittings	14	
Istruzioni di assemblaggio FR5T DN4 / <i>Assembly Instructions FR5 DN4</i>	15	
Accessori serie FR5T / FR5T Series Accessories	16	
	Tubi FR5T / FR5T Hoses	18
Caratteristiche tecniche / <i>Technical Features</i>	19	
Raccordi per tubo FR5T con pressa professionale/ FR5T Hose Fittings with professional crimping tool	20	
Accessori serie FR5T / FR5T Series Accessories	21	
	Tubi FR5A / FR5A Hoses	22
Caratteristiche tecniche / <i>Technical Features</i>	24	
Raccordi per tubo FR5A con pressa professionale / FR5A Hose Fittings with professional crimping tool	25	
Istruzioni di saldatura ermeti in rame / <i>Copper Pipe Welding Instructions</i>	26	
	Tubi corrugati FR5C / Corrugated bore hoses FR5C	27
Caratteristiche tecniche / <i>Technical Features</i>	27	
	Tubi carica TLP / TLP Charging Hoses	28
Caratteristiche tecniche / <i>Technical Features</i>	28	
Raccordi per tubo carica TLP / TLP Charging Hose Fittings	29	
Accessori serie TLP / TLP Series Accessories	31	
Indicazioni di montaggio / Installation Instructions	33	
Performance dei tubi / Hose Performance	34	

ZEC S.p.A.: Flessibilità per scelta

ZEC S.p.A., fondata nel 1961 da Eugenio Zantelli a Colorno, in provincia di Parma, produce tubi termoplastici per applicazioni a bassa, media, alta e altissima pressione.

A partire dal 1990 le attività commerciali sul mercato domestico sono estese all'espansione sui mercati internazionali.

Investimenti in risorse umane particolarmente qualificate, impianti di produzione tecnologicamente avanzati, attività di ricerca e sviluppo e la presenza commerciale favoriscono l'espansione sui mercati globali, dove ZEC S.p.A. oggi è presente in più di 90 paesi.

La considerevole crescita in tutte le aree è stata accompagnata da una gamma di prodotti sempre più ampia, dedicata a numerosi settori applicativi, quali oleodinamica, pneumatica, lubrificazione, automotive, alimentare, navale, refrigerazione, petrochimico-offshore, etc.

La gamma di prodotti di ZEC S.p.A. comprende tubi termoplastici standard o customizzati singoli, multipli e spiralati, con caratteristiche tecniche da 2mm a 40mm di diametro interno, pressioni di lavoro da 5bar a 1280bar e temperature di esercizio da -200°C a +260°C.

Tutti i tubi termoplastici di ZEC S.p.A. sono prodotti di materie prime di primaria qualità accuratamente selezionate. Ogni fase del ciclo produttivo è soggetta a severi controlli qualitativi.

La produzione avviene esclusivamente all'interno dei ns. stabilimenti a Colorno, Italia.

I prodotti finiti sono conformi alle principali normative internazionali dei rispettivi settori applicativi, quali SAE, EN, ISO e DIN.

ZEC S.p.A. opera in regime di qualità UNI EN ISO 9001-2015.

ZEC S.p.A.: Flexibility for Choice

ZEC S.p.A., founded in 1961 by Mr. Eugenio Zantelli in Colorno, Province of Parma, Italy, manufactures thermoplastic hoses for low, medium, high and very high pressure applications.

Since 1990, the artisan approach to the production has been boosted by an international breakthrough. Investments in special skilled human resources, manufacturing, product innovations and commercial presence elevates ZEC S.p.A. meanwhile into the global market, covering more than 90 countries world wide.

The global expansion of the Company has been accompanied with the constant development of the product range dedicated to a large portfolio of applications such as fluid power, pneumatics, lubrication, automotive, food processing, marine, refrigeration, petrochemical-offshore, and so on.

The ZEC S.p.A. product range includes standard or customized single, multiple and coiled thermoplastic hoses, with technical characteristics within the range of 2mm to 40mm inner diameter, working pressures from 5bar to 1280bar and operating temperatures from -200°C to +260°C.

All products manufactured by ZEC S.p.A. are of top quality and carefully selected raw materials. Manufacturing processes are continuously multiple controlled.

The entire production takes place in our facilities located in Colorno, Italy.

End products comply strictly with major international standards such as SAE, EN, DIN & ISO.

All company sectors and activities are qualified and operate according to UNI EN ISO 9001-2015 quality system.

Refrigeration

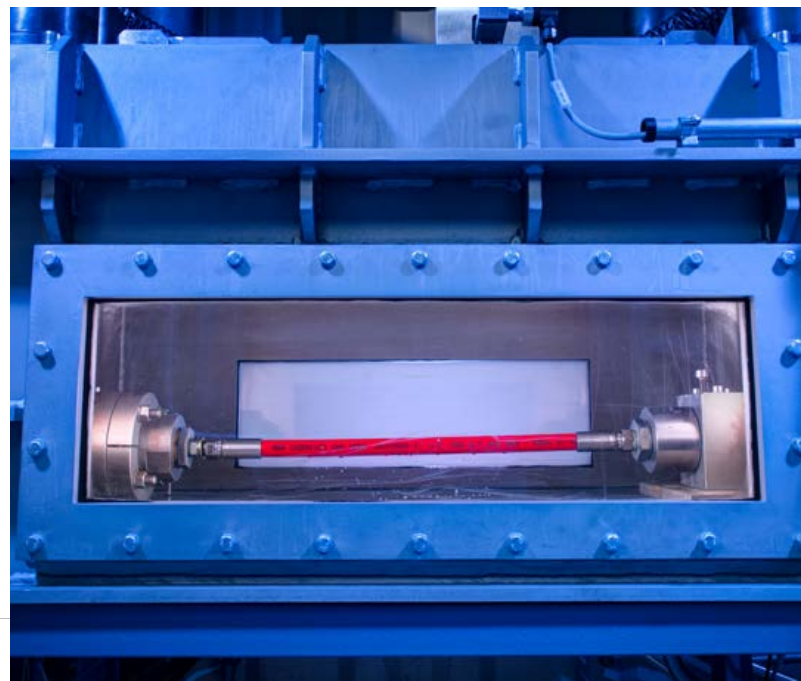
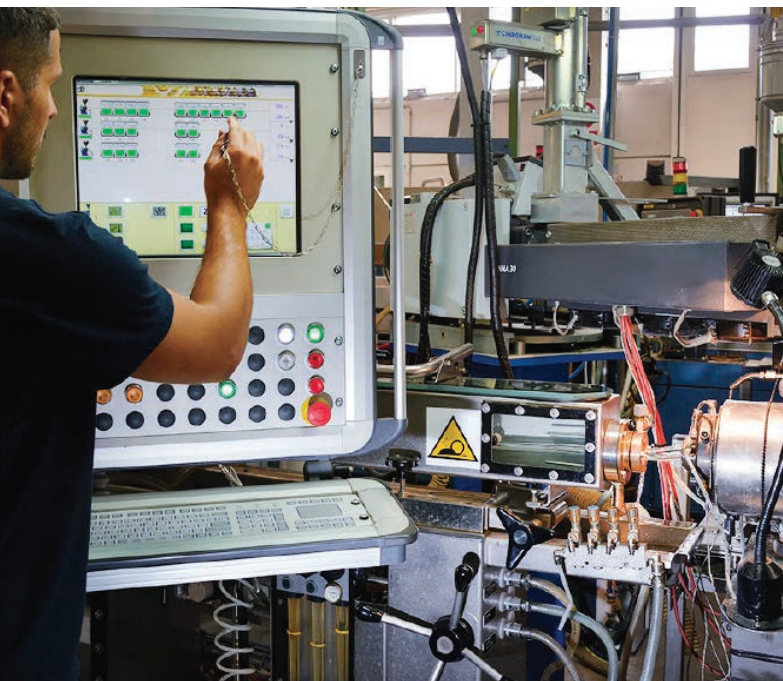
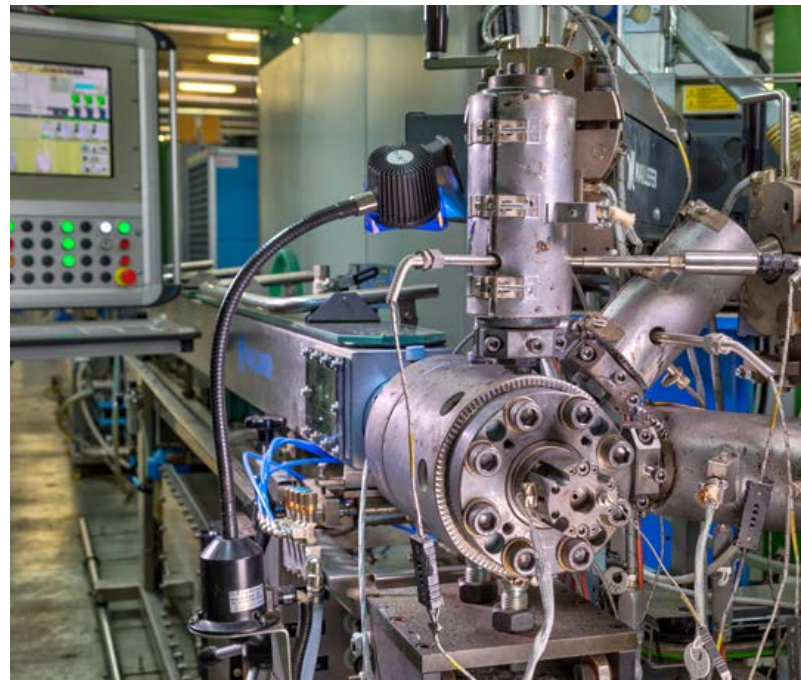
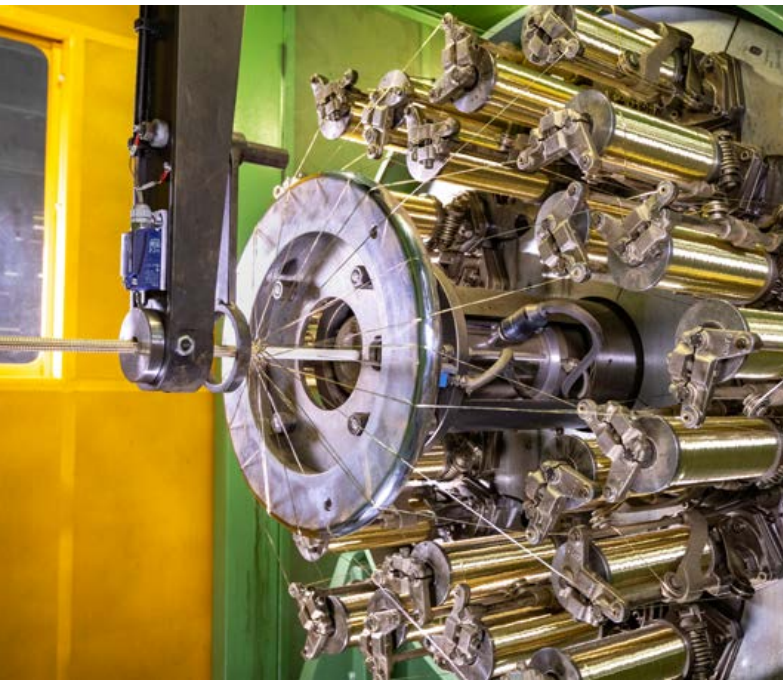

Qualità

I tubi sono conformi o superiori alle norme **UNI EN 1736, ISO 13971 e UL 1963**, alle normative **SAE J2196 e SAE J2888**, al **Regolamento "REACH"(2006/1907/CE)**, alla **Direttiva Europea "RoHS" (2011/65/UE)**.

Il sistema di qualità certificato **ISO 9001:2015 di ZEC** assicura il continuo e costante controllo del processo di produzione, garantendo il rispetto delle buone pratiche di fabbricazione.

Caratteristiche tecniche

Le certificazioni su prodotti specifici, dichiarazioni di conformità varie di prodotto e di materiali, documenti tecnici, manuali ed istruzioni, tabella di compatibilità e tabella di pressatura sono disponibili in Area Riservata: www.zecspa.com/it/area-riservata



Quality

*The hoses meet or exceed **UNI EN 1736, ISO 13971 and UL 1963 standards, SAE J2196 and SAE J2888, "REACH" Regulation (2006/1907/EC), "RoHS" European Directive (2004/65/EU).***

*The certified **ISO 9001:2015 ZEC** quality system ensures a continuous and constant control of the production process, guaranteeing compliance with Good Manufacturing Practices.*

Technical Data

Certifications on specific products, as well as declarations of conformity, together with other technical documents, manuals and instructions, compatibility and crimping tables are available in our Reserved Area: www.zecspa.com/en/reserved-area

Imballi - Kit tubi e raccordi capillari

Le scatole di cartone per tubi (10m e 50m) e per raccordi (25pz e 50pz) garantiscono l'integrità dei prodotti e consentono uno stoccaggio adeguato, sia sullo scaffale di rivendita che dopo l'apertura della confezione.

Soluzione ideale per il mercato della distribuzione.

Packaging - Capillary Hoses and Fittings Kits

Cardboard boxes for hoses (10m and 50m) and for fittings (25pcs and 50pcs) preserve the product's integrity and allow proper storage, on the resale shelf and after package's opening. An ideal solution for the retail market.



Area di assemblaggio

L'area di assemblaggio dedicata garantisce precisione e rapidità di esecuzione per soddisfare anche i costruttori di impianti più esigenti.

Assembly Area

The dedicated assembly area ensures precision and fast execution to satisfy even the most demanding system manufacturers.



Etichettatura e tracciabilità

Qualità tracciabile e possibilità di personalizzazione. La personalizzazione delle etichette e l'utilizzo di QR code forniscono al cliente la totale tracciabilità dei componenti nonché la garanzia del prodotto finito.

Labeling and Traceability

Total traceability is assured by means of a resistant QR code label and automated code scanning system. Customization of the labels is available on request.



Le soluzioni ZEC per la refrigerazione

I tubi termoplastici ZEC per la refrigerazione trovano impiego nei sistemi di refrigerazione per il settore impiantistico industriale e per quello commerciale, sostituendosi alle tubazioni in rame.

CARATTERISTICHE E BENEFICI

- soluzione flessibile e di facile installazione
- bassa permeabilità ai gas refrigeranti (compresa la CO₂)
- eliminazione perdite a causa di vibrazioni / movimenti del sistema
- elevata compatibilità chimica e resistenza rispetto ad agenti atmosferici
- riduzione dei processi di saldatura / brasatura

APPLICAZIONI

- sistemi di controllo di pressione (pressostati) dei gas refrigeranti attraverso tubi capillari
- gestione gas refrigeranti su impianti commerciali (vetrine, frigoriferi espositori, cantinette, dispenser, ecc.)
- impianti refrigeranti (chillers) applicati su macchine utensili in genere
- sistemi di condizionamento industriale
- sistemi di raffreddamento per il trasporto refrigerato
- impianti di ricarica di gas refrigerante per i sistemi di condizionamento del settore automotive



ZEC Solutions for Refrigeration Systems

ZEC hoses are specifically designed for industrial and commercial applications to replace the traditional copper tubes.

FEATURES AND BENEFITS

- *flexible and easy to install*
- *low permeability to refrigerant gases (including CO₂ and ammonia)*
- *elimination of leakages caused by vibrations / movements of the system*
- *high chemical compatibility and resistance against atmospheric agents*
- *reduction of welding / brazing processes*

APPLICATIONS

- *pressure control systems (pressure gauges) of the refrigerant gases through capillary hoses*
- *management of refrigerant gases on commercial equipment (display cabinets, display refrigerators, wine cellars, dispensers, etc.)*
- *cooling systems (chillers) applied on tooling machines in general*
- *industrial conditioning systems*
- *cooling systems for refrigerated transport*
- *refrigerant gas recharging systems for automotive air conditioning systems*



Tubi termoplastici e raccordi per la refrigerazione *Thermoplastic Hoses and Fittings for Refrigeration Systems*



Tubi capillari FR5T
FR5T Capillary Hoses

Tubi FR5A per la CO₂
FR5A Hoses for CO₂ lines

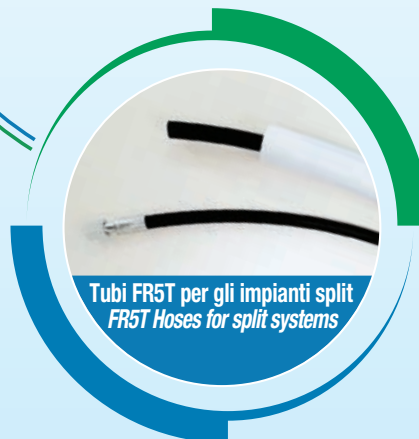

Tubi FR5T per gli impianti split
FR5T Hoses for split systems

**Conformi alla normativa
EN 1736 CLASSE 1
i tubi ZEC FR5**
garantiscono una bassa permeabilità
ai gas refrigeranti.

**Developed in compliance with
EN 1736 CLASS 1
all ZEC FR5 hoses**
assure the lowest permeability
to refrigerant gases.



Zec è proattiva nel trovare soluzioni alle
sfide ambientali. Per questo crea prodotti di
alta qualità, progettati per durare nel tempo.

*Zec is proactive in finding solutions to
environmental challenges. This has
meant creating high-quality products,
designed to last.*



Tubi capillari FR5T

I capillari ZEC rappresentano la soluzione più efficiente per il collegamento di manometri, pressostati e per le linee di ritorno dell'olio.

Flessibili e particolarmente resistenti alle alte pressioni, i capillari ZEC riducono in maniera significativa le vibrazioni dell'intero sistema.

I capillari ZEC sono disponibili nelle colorazioni nera, rossa e blu, permettendo di distinguere i circuiti a bassa ed alta pressione.

I nostri capillari possono essere facilmente assemblati utilizzando la pinza PZFR5DN2, la pressa portatile PZFR5DN4 o la pressa elettrica PZBCFR5.

FR5T Capillary Hoses

ZEC capillary hoses are the most efficient solution for the connection of manometres, pressure gauges and for oil return lines. Flexible and highly pressure resistant, ZEC capillaries significantly reduce vibrations of the entire system.

The capillaries are available in black, red and blue colours, defining the phases of refrigeration circuits (high and low pressure).

ZEC capillaries can be easily assembled with the specific ZEC hand pliers PZFR5DN2, ZEC crimping tool PZFR5DN4 or electrical crimping tool PZBCFR5.



TUBI CAPILLARI FR5T FR5T CAPILLARY HOSES



Caratteristiche tecniche

- **Caratteristiche tecnico-costruttive:**
Tubi capillari DN2 e DN4 coestrusi treccia tessile con interno liscio e rivestimento in poliuretano.
- **Temperature di utilizzo:**
Da -40°C a +120°C
Temperatura di picco max. 130°C
- **Pressioni d'esercizio:**
Rapporto di sicurezza superiore ai requisiti della EN 1736 e ISO 13971
- **Valore max. di vuoto:** 5 mbar
- **Specifiche:**
Conformi alle norme EN 1736, ISO 13971 classe 1 e UL 1963.

Technical Features

- **Technical-constructive features:**
Smooth bore coextruded textile braid capillary hoses DN2 and DN4 with polyurethane cover.
- **Working temperatures:**
From -40°C to +120°C from -40°F to +248°F
Max. peak temperature 130°C / 266°F
- **Working pressure:**
Safety ratio exceeding EN 1736 and ISO 13971 requirements
- **Vacuum rating:** 5 mbar
- **Specifications:**
Compliant with EN 1736, ISO 13971 class 1 and UL 1963.

Scheda tecnica - Datasheet



CODE	inch	mm	DN	inch	mm	bar	psi	mm	inch	g/m	lbs/ft	FERRULE CODE
FR5T170*	1/12"	2.1	2	0.236	6.0	130	1885	15	0.590	27	0.018	BP112FR5AA
FR5T270*	5/32"	4.0	4	0.323	8.2	130	1885	30	1.181	45	0.030	BP532FR5

N.B. Nel codice compare un *, bisogna sostituirlo con la sigla del colore del tubo: NERO (N), BLÙ (B) o ROSSO (R).
Esempio: Tubo 1/12" nero – codice FR5T170N.

N.B. In the code there is an *, this must be replaced with the color code of the tube: BLACK (N), BLUE (B) or RED (R)
Example: Tube 1/12" black – code FR5T170N

Tipo / Type	Codice / Part Nr.	Colore / Colour	Descrizione / Description
DN2 - TUBI / HOSES	FR5T170N	●	ROTOLO LIBERO / FREE COIL
	FR5T1NR010	●	SCATOLA 10 M / 10M CARTON BOX
	FR5T1NR050	●	SCATOLA 50 M / 50M CARTON BOX
	FR5T170R	●	ROTOLO LIBERO / FREE COIL
	FR5T1RR010	●	SCATOLA 10 M / 10M CARTON BOX
	FR5T1RR050	●	SCATOLA 50 M / 50M CARTON BOX
	FR5T170B	●	ROTOLO LIBERO / FREE COIL
	FR5T1BR010	●	SCATOLA 10 M / 10M CARTON BOX
	FR5T1BR050	●	SCATOLA 50 M / 50M CARTON BOX
	DN4 - TUBI / HOSES	FR5T270N	●
FR5T2NR010		●	SCATOLA 10 M / 10M CARTON BOX
FR5T2NR050		●	SCATOLA 50 M / 50M CARTON BOX
FR5T270R		●	ROTOLO LIBERO / FREE COIL
FR5T2RR010		●	SCATOLA 10 M / 10M CARTON BOX
FR5T2RR050		●	SCATOLA 50 M / 50M CARTON BOX
FR5T270B		●	ROTOLO LIBERO / FREE COIL
FR5T2BR010		●	SCATOLA 10 M / 10M CARTON BOX
FR5T2BR050		●	SCATOLA 50 M / 50M CARTON BOX

Raccordi per tubo capillare FR5T DN2 / FR5T Capillary Hose Fittings DN2

RACCORDO FEMMINA DIRITTA 1/4" SAE
1/4" SAE STRAIGHT FEMALE FITTING



Codice / Part Nr.	Pezzi / Pcs
FR5T1K001AA	1
FR5T1K025AA	25
FR5T1K050AA	50
Codice / Part Nr.	Descrizione / Description
YDLSA7160TM	DADO 7/16" SAE OTTONE / NUT 7/16" SAE BRASS
YFDLSAOC7161120T	FEMM. D. 1/4" SAE OTTONE / S. FEM. 1/4" SAE BRASS
BP112FR5AA	BOCCOLA IN ALLUMINIO PER TUBO DN2 / DN2 ALUMINIUM FERRULE

RACCORDO FEMMINA DIRITTA 1/4" SAE CON DEPRESSORE
1/4" SAE STRAIGHT FEMALE FITTING WITH DEPRESSOR



Codice / Part Nr.	Pezzi / Pcs
FR5T1K001GA	1
FR5T1K025GA	25
FR5T1K050GA	50
Codice / Part Nr.	Descrizione / Description
YDLSA7160TM	DADO 7/16" SAE OTTONE / NUT 7/16" SAE BRASS
YFDLSAOC7161120T	FEMM. D. 1/4" SAE CON DEP. OTTONE / S. FEM. 1/4" SAE WITH DEP. BRASS
BP112FR5AA	BOCCOLA IN ALLUMINIO PER TUBO DN2 / DN2 ALUMINIUM FERRULE

RACCORDO FEMMINA 90° 1/4" SAE
1/4" SAE 90° FEMALE FITTING



Codice / Part Nr.	Pezzi / Pcs
FR5T1K001BA	1
FR5T1K025BA	25
FR5T1K050BA	50
Codice / Part Nr.	Descrizione / Description
RPF914SAE112FR5	FEMM. 90° 1/4" SAE OTTONE / 90° FEM. 1/4" SAE BRASS
BP112FR5AA	BOCCOLA IN ALLUMINIO PER TUBO DN2 / DN2 ALUMINIUM FERRULE

RACCORDO A "T"
"T" FITTING



Codice / Part Nr.	Pezzi / Pcs
FR5T1K001T	1
FR5T1K025T	25
FR5T1K050T	50
Codice / Part Nr.	Descrizione / Description
RFR51120012	RACCORDO A "T" OTTONE ZINCATO / "T" ZINC PLATED BRASS
3X BP112FR5AA	BOCCOLA IN ALLUMINIO PER TUBO DN2 / DN2 ALUMINIUM FERRULE

RACCORDO A "T" CON DADO CENTRALE
"T" FITTING WITH CENTRAL NUT



Codice / Part Nr.	Pezzi / Pcs
FR5T1K001TC	1
FR5T1K025TC	25
FR5T1K050TC	50
Codice / Part Nr.	Descrizione / Description
RFR51120117	RACCORDO A "T", DADO CENTRALE 1/4" SAE OTTONE ZINCATO / 1/4" SAE "T" FITTING, CENTRAL NUT ZINC PLATED BRASS
2X BP112FR5AA	BOCCOLA IN ALLUMINIO PER TUBO DN2 / DN2 ALUMINIUM FERRULE

RACCORDO A "T" CON DADO LATERALE
"T" FITTING WITH SIDE NUT



Codice / Part Nr.	Pezzi / Pcs
FR5T1K001TL	1
FR5T1K025TL	25
FR5T1K050TL	50
Codice / Part Nr.	Descrizione / Description
RFR51120118	RACCORDO A "T", DADO LATERALE 1/4" SAE OTTONE ZINCATO / 1/4" SAE "T" FITTING, SIDE NUT ZINC PLATED BRASS
2X BP112FR5AA	BOCCOLA IN ALLUMINIO PER TUBO DN2 / DN2 ALUMINIUM FERRULE

RACCORDO MASCHIO DIRITTO 1/4" SAE 1/4" SAE STRAIGHT MALE FITTING

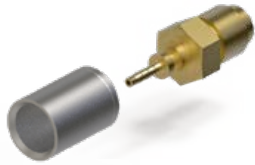

Codice / Part Nr.	Pezzi / Pcs
FR5T1K001CA	1
FR5T1K025CA	25
FR5T1K050CA	50

Codice / Part Nr.	Descrizione / Description
RPMD14SAE112FR5	MASCHIO D. 1/4" SAE OTTONE / ST. MALE 1/4" SAE BRASS
BP112FR5AA	BOCCOLA IN ALLUMINIO PER TUBO DN2 / DN2 ALUMINIUM FERRULE

TUBOLARE IN RAME DN 6MM COPPER PIPE DN 6MM

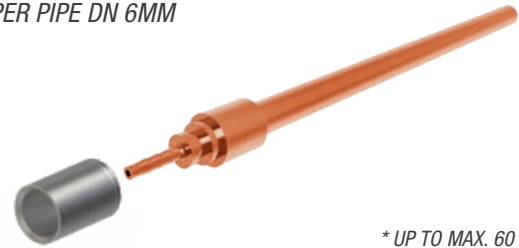

* UP TO MAX. 60 BAR

Codice / Part Nr.	Descrizione / Description	Pezzi / Pcs
FR5T1K001DG	TUBOLARE IN RAME DN 6MM COPPER PIPE DN 6MM	1
FR5T1K025DG	TUBOLARE IN RAME DN 6MM COPPER PIPE DN 6MM	25



Raccordi per DN2
Fittings for DN2

ISTRUZIONI DI ASSEMBLAGGIO FR5T DN2 / ASSEMBLY INSTRUCTIONS FR5T DN2



1
Tagliare il tubo della lunghezza voluta usando le apposite pinze taglia tubo. Il taglio deve essere perfettamente perpendicolare.
Cut the hose at the required length using the proper hose cutter. The cut must be perpendicular to the hose's longitudinal axis.

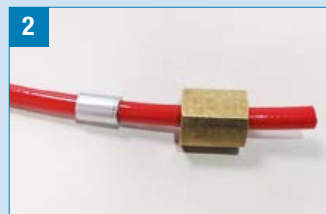

2
Inserire la boccola con l'incisione rivolto verso il lato appena tagliato. Spingere la boccola lungo il tubo. Inserire il dado con il filetto rivolto verso il lato tagliato.
Insert the ferrule with the incision on the side of the cut hose. Move the ferrule along the hose. Insert the nut with the thread on the side of the cut.

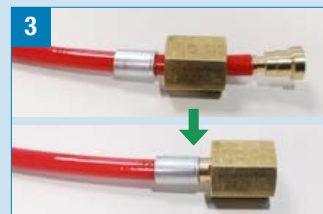

3
Inserire l'inserto all'interno del tubo fino in battuta e far scorrere il dado. Far scorrere anche la boccola fino in battuta contro l'inserto. Non ci deve essere spazio tra la boccola e l'inserto.
Push the fitting insert into the hose all way down and slide the nut. Slide also the ferrule until it stops against the insert. There must be no space between the ferrule and the insert.



4
Pressare la boccola con le pinze manuali. Le ganasce della pinza devono stringere la boccola in tutta la sua lunghezza. Tenere le pinze serrate per almeno 10 secondi.
Crimp the ferrule with the manual crimping pliers. The pliers' die must cover the whole ferrule length. Keep the pliers completely tight for 10 seconds at least.



5
Ruotare la boccola di 90° e ripetere la pressatura.
Turn the ferrule of 90° and crimp again.



6
Ispezionare il tubo pressato. La boccola deve essere pressata uniformemente lungo tutta la lunghezza. Nel caso la raccordatura non sia stata eseguita correttamente, tagliare il tubo e riprovare con un nuovo raccordo.
Make visual inspections of the fittings after the crimping. The ferrule must be uniformly crimped. In case of an incorrect crimping you have to cut the hose and retry with a new ferrule.



7
Controllare il diametro di pressatura, facendo la media tra due misurazioni a 90° e verificare che corrisponda con i dati riportati sulla Tabella di Pressatura ZEC.
Check the crimping diameter by averaging two measurements at 90° and verify that it corresponds with the data shown on the ZEC Crimping Table.



8
Se dopo diversi utilizzi il diametro di pressatura tende ad aumentare, regolare l'ingranaggio della pinza.
If after several uses the measured crimping diameter tends to increase, adjust the gear of the plier.

Raccordi per tubo capillare FR5T DN4 / FR5T Capillary Hose Fittings DN4

RACCORDO FEMMINA DIRITTA 1/4" SAE
1/4" SAE STRAIGHT FEMALE FITTING



Codice / Part Nr.	Pezzi / Pcs
FR5T2K001AA	1
FR5T2K025AA	25
FR5T2K050AA	50
Codice / Part Nr.	Descrizione / Description
YDLSA7160TM	DADO 7/16" SAE OTTONE / NUT 7/16" SAE BRASS
YFDLSAFR716532	FEMM. D. 1/4" SAE ACCIAIO AVP / S. FEM. 1/4" SAE CARBON STEEL
BP532FR5	BOCCOLA IN ACCIAIO PER TUBO DN4 / DN4 CARBON STEEL FERRULE

RACCORDO FEMMINA DIRITTA 1/4" SAE CON DEPRESSORE
1/4" SAE STRAIGHT FEMALE FITTING WITH DEPRESSOR



Codice / Part Nr.	Pezzi / Pcs
FR5T2K001GA	1
FR5T2K025GA	25
FR5T2K050GA	50
Codice / Part Nr.	Descrizione / Description
YDLSA7160TM	DADO 7/16" SAE OTTONE / NUT 7/16" SAE BRASS
YFDLSADOC716532	FEMM. D. 1/4" SAE CON DEP. ACCIAIO AVP/S. FEM. 1/4" SAE WITH DEP. CARBON STEEL
BP532FR5	BOCCOLA IN ACCIAIO PER TUBO DN4 / DN4 CARBON STEEL FERRULE

RACCORDO FEMMINA DIRITTA 3/8" SAE
3/8" SAE STRAIGHT FEMALE FITTING



Codice / Part Nr.	Pezzi / Pcs
FR5T2K001AC	1
FR5T2K025AC	25
FR5T2K050AC	50
Codice / Part Nr.	Descrizione / Description
YDLSA58M	DADO 3/8" SAE ACCIAIO / NUT 3/8" SAE STEEL
YFDLSAFR58532	FEMM. D. 3/8" SAE ACCIAIO AVP / S. FEM. 3/8" SAE CARBON STEEL
BP532FR5	BOCCOLA IN ACCIAIO PER TUBO DN4 / DN4 CARBON STEEL FERRULE

RACCORDO FEMMINA 90° 1/4" SAE
1/4" SAE 90° FEMALE FITTING



Codice / Part Nr.	Pezzi / Pcs
FR5T2K001BA	1
FR5T2K025BA	25
FR5T2K050BA	50
Codice / Part Nr.	Descrizione / Description
RPF914SAE532FR5	FEMM. 90° 1/4" SAE ACCIAIO AVP, DADO OTTONE ZINCATO / 90° FEM. 1/4" SAE CARBON STEEL, NUT ZINC PLATED BRASS
BP532FR5	BOCCOLA IN ACCIAIO PER TUBO DN4 / DN4 CARBON STEEL FERRULE

RACCORDO FEMMINA 90° 3/8" SAE
3/8" SAE 90° FEMALE FITTING



Codice / Part Nr.	Pezzi / Pcs
FR5T2K001BC	1
FR5T2K025BC	25
FR5T2K050BC	50
Codice / Part Nr.	Descrizione / Description
YDLSA58M	DADO SAE 3/8" ACCIAIO / NUT SAE 3/8" STEEL
YF90LSAFR58532	FEMM. 90° 3/8" SAE ACCIAIO AVP / 90° FEM. 3/8" SAE CARBON STEEL
BP532FR5	BOCCOLA IN ACCIAIO PER TUBO DN4 / DN4 CARBON STEEL FERRULE

RACCORDO A "T"
"T" FITTING



Codice / Part Nr.	Pezzi / Pcs
FR5T2K001T	1
FR5T2K025T	25
FR5T2K050T	50
Codice / Part Nr.	Descrizione / Description
RFR54112	RACCORDO A "T" ACCIAIO AVP / "T" FITTING CARBON STEEL
3X BP532FR5	BOCCOLA IN ACCIAIO PER TUBO DN4 / DN4 CARBON STEEL FERRULE

RACCORDO A "T" CON DADO CENTRALE "T" FITTING WITH CENTRAL NUT



Codice / Part Nr.	Pezzi / Pcs
FR5T2K001TC	1
FR5T2K025TC	25
FR5T2K050TC	50
Codice / Part Nr.	Descrizione / Description
RFR54117	RACCORDO A "T", DADO CENTRALE 1/4" SAE ACCIAIO AVP / "T" FITTING, CENTRAL NUT 1/4" SAE CARBON STEEL
2X BP532FR5	BOCCOLA IN ACCIAIO PER TUBO DN4 / DN4 CARBON STEEL FERRULE

RACCORDO A "T" CON DADO LATERALE "T" FITTING WITH SIDE NUT



Codice / Part Nr.	Pezzi / Pcs
FR5T2K001TL	1
FR5T2K025TL	25
FR5T2K050TL	50
Codice / Part Nr.	Descrizione / Description
RFR54118	RACCORDO A "T", DADO LATERALE 1/4" SAE ACCIAIO AVP / "T" FITTING, SIDE NUT 1/4" SAE CARBON STEEL
2X BP532FR5	BOCCOLA IN ACCIAIO PER TUBO DN4 / DN4 CARBON STEEL FERRULE

RACCORDO MASCHIO DIRITTO 1/4" SAE 1/4" SAE STRAIGHT MALE FITTING



Codice / Part Nr.	Pezzi / Pcs
FR5T2K001CA	1
FR5T2K025CA	25
FR5T2K050CA	50
Codice / Part Nr.	Descrizione / Description
RPMD14SAE532FR5	MASCHIO D.1/4" SAE ACCIAIO AVP / S. MALE 1/4" SAE CARBON STEEL
BP532FR5	BOCCOLA IN ACCIAIO PER TUBO DN4 / DN4 CARBON STEEL FERRULE

TUBOLARE IN RAME DN 6MM COPPER PIPE DN 6MM



* UP TO MAX. 60 BAR

Codice / Part Nr.	Descrizione / Description	Pezzi / Pcs
FR5T2K001DG	TUBOLARE IN RAME DN 6MM COPPER PIPE DN 6MM	1
FR5T2K025DG	TUBOLARE IN RAME DN 6MM COPPER PIPE DN 6MM	25

ISTRUZIONI DI ASSEMBLAGGIO FR5T DN4 / ASSEMBLY INSTRUCTIONS FR5T DN4



1
Tagliare il tubo della lunghezza voluta usando le apposite pinze taglia tubo. Il taglio deve essere perfettamente perpendicolare.
Cut the hose at the required length using the proper hose cutter. The cut must be perpendicular to the hose's longitudinal axis.



2
Inserire la boccola con l'intaglio rivolto verso il lato appena tagliato.
Insert the ferrule with the incision on the side of the cut hose.



3
Inserire l'inserto provvisto di dado fino in battuta.
Insert the fittings with his nut until the stop.



4
Far scorrere la boccola in direzione del dado fino in battuta. Non ci deve essere più spazio tra la boccola e l'inserto.
Slide the ferrule until it stops. There must be no more space between the ferrule and the insert.



5
Pressare la boccola usando attrezzature adeguate. Chiudere le matrici fino all'apertura automatica delle stesse. Le ganasce della pinza devono stringere la boccola in tutta la sua lunghezza.
Crimp the ferrule using a proper crimping tool and die set. Close the die until they automatically open. The pliers' die must cover the whole ferrule length.



6
Ruotare la boccola di 90° e pressare nuovamente.
Turn the ferrule of 90° and crimp again.



7
Ispezionare il tubo pressato. La boccola deve essere pressata uniformemente lungo tutta la lunghezza. Nel caso la raccordatura non sia stata eseguita correttamente, tagliare il tubo e riprovare con un nuovo raccordo.
Make visual inspections of the fittings after the crimping. The ferrule must be uniformly crimped. In case of an incorrect crimping you have to cut the hose and retry with a new ferrule.



8
Controllare il diametro di pressatura, facendo la media tra due misurazioni a 90° e verificare che corrisponda con i dati riportati sulla Tabella di Pressatura ZEC.
Check the crimping diameter by averaging two measurements at 90° and verify that it corresponds with the data shown on the ZEC Crimping Table.

Accessori serie FR5T / FR5T Series Accessories

TAPPO DI PROTEZIONE
PROTECTIVE PLASTIC PLUG



Codice / Part Nr.	Pezzi / Pcs	SAE
TAPPOPE14SAEKC	50	1/4"
TAPPOPE38SAEKC	50	3/8"

GUARNIZIONE IN RAME
COPPER WASHER



CONICA IMBUTO
CONIC FUNNEL

Codice / Part Nr.	Pezzi / Pcs	SAE
GCICU14FR5KC	50	1/4"
GCICU38FR5KC	50	3/8"
GCICU12FR5KC	50	1/2"
GCICU58FR5KC	50	5/8"
GCICU34FR5KC	50	3/4"

GUARNIZIONE IN RAME
COPPER WASHER



CONICA
CONIC

Codice / Part Nr.	Pezzi / Pcs	SAE
GCCU14FR5KC	50	1/4"
GCCU38FR5KC	50	3/8"
GCCU12FR5KC	50	1/2"
GCCU58FR5KC	50	5/8"
GCCU34FR5KC	50	3/4"

PREMISPILLO RACCORDO IN OTTONE
BRASS DEPRESSOR

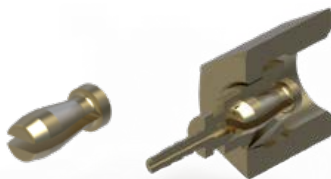

Codice / Part Nr.	Pezzi / Pcs	SAE
VFR5DN2TKC	50	1/4"

PINZA A CRIMPERE PER BOCCOLA DN2
CRIMPING TOOL FOR DN2 FERRULE



Codice / Part Nr.
PZFR5DN2

PINZE TAGLIA TUBO
HOSE CUTTER



Codice / Part Nr.	Descrizione / Description
PZG1	Taglia-tubi per diametro esterno fino a 28.0 mm. / Cutter up to a maximum external diameter of 28.0 mm.
PZP1	Taglia-tubi per diametro esterno fino a 12 mm. / Cutter up to a maximum external diameter of 12 mm.
LMG1	Lame di ricambio per taglia-tubi PZG1 Replacement blades for tube cutter PZG1
LMP1	Lame di ricambio per taglia-tubi PZP1 Replacement blades for tube cutter PZP1

Accessori serie FR5T / FR5T Series Accessories

UTENSILE OLEODINAMICO PER CRIMPAGGIO BOCCOLE DN2-4-6
 FLUID POWER CRIMPING TOOL FOR DN2-4-6 FERRULES



DN4
 Procedura di montaggio elettrico
 Electric assembly procedure

Codice / Part Nr.

PZBCFR5



PINZA A CRIMPARE PER BOCCOLE DN2-4-6
 CRIMPING TOOL FOR DN2-4-6 FERRULES



DN4
 Procedura di montaggio manuale
 Manual assembly procedure

Codice / Part Nr.

PZFR5DN4



Matrici / Die set	Codice Tubo / Hose Code	inch	Raccordi / Fittings	Descrizione / Description	Raccordi / Fittings	Descrizione / Description
MPZBCFR5DN2	FR5T170N FR5T170B FR5T170R DN2	1/12"	FR5T1K001AA	FEMM. D. 1/4" SAE / S. FEM. 1/4" SAE	FR5T1K001T	RACCORDO A "T" / "T" FITTING
			FR5T1K001GA	FEMM. D. 1/4" SAE CON DEP. / S. FEM. 1/4" SAE WITH DEP	FR5T1K001TC	RACCORDO A "T" CON DADO CENTRALE / "T" FITTING WITH CENTRAL NUT
			FR5T1K001BA	FEMM. 90° 1/4" SAE / 90° FEM. 1/4" SAE	FR5T1K001TL	RACCORDO A "T" CON DADO LATERALE / "T" FITTING WITH LATERAL NUT
			FR5T1K001CA	MASCHIO D. 1/4" SAE / S. MALE 1/4" SAE		
MPZBCFR5DN4	FR5T270N FR5T270B FR5T270R DN4	5/32"	FR5T2K001AA	FEMM. D. 1/4" SAE / S. FEM. 1/4" SAE	FR5T2K001BA	FEMM. 90° 1/4" SAE / 90° FEMALE 1/4" SAE
			FR5T2K001GA	FEMM. D. 1/4" SAE CON DEP. / S. FEM. 1/4" SAE WITH DEP.	FR5T2K001T	RACCORDO A "T" / "T" FITTING
			FR5T2K001AC	FEMM. D. 3/8" SAE / S. FEM. 3/8" SAE	FR5T2K001TC	RACCORDO A "T" CON DADO CENTRALE / "T" FITTING WITH CENTRAL NUT
			FR5T2K001BC	FEMM. 90° 3/8" SAE / 90° FEM. 3/8" SAE	FR5T2K001TL	RACCORDO A "T" CON DADO LATERALE / "T" FITTING WITH LATERAL NUT
			FR5T2K001CA	MASCHIO D. 1/4" SAE / S. MALE 1/4" SAE		
MPZBCFR5DN6	FR5T490N DN6	5/16"	FR5T4KA01AA	FEMM. D. 1/4" SAE, BOCCOLA IN ALL. / S. FEM. 1/4" SAE, AL. FERRULE	FR5T4KA01AC	FEMM. D. 3/8" SAE, BOCCOLA IN ALL. / S. FEM. 3/8" SAE, AL. FERRULE
			FR5T4KA01BA	FEMM. 90° 1/4" SAE, BOCCOLA IN ALL. / 90° FEM. 1/4" SAE, AL. FERRULE	FR5T4KA01BC	FEMM. 90° 3/8" SAE, BOCCOLA IN ALL. / 90° FEM. 3/8" SAE, AL. FERRULE



Tubi FR5T

I tubi ZEC per gli impianti split ad uso domestico ed industriale sono stati specificatamente progettati per lo scarico, l'aspirazione e per collegare l'evaporatore all'unità motocondensante, riducendo in maniera significativa i tempi di installazione.
Disponibile anche in versione pre-isolata.

FR5T Hoses

*ZEC hoses for split systems have been developed specifically for discharge, suction and to connect the evaporator to the condensing units in domestic and industrial air conditioning, reducing significantly the installation time.
Available also in pre-insulated version.*



FR5T PRE-INSULATED
Installazione impianto split
Split system installation



TUBI FR5T FR5T HOSES



Caratteristiche tecniche

- **Caratteristiche tecnico-costruttive:**
Tubi coestrusi treccia tessile con interno liscio.
Soluzione sviluppata per impianti refrigeranti e idonea anche per impianti Aria Condizionata per uso domestico ed industriale.
- **Temperature di utilizzo:**
Da -40°C a +120°C
Temperatura di picco max. 130°C
Con isolamento massima temperatura +110°C (230°F)
- **Pressioni d'esercizio:**
Rapporto di sicurezza superiore ai requisiti della EN 1736 e ISO 13971
- **Valore max. di vuoto:** 5 mbar
- **Specifiche:**
Conformi alle norme EN 1736, ISO 13971 classe 1 e UL 1963.

Technical Features

- **Technical-constructive features:**
Smooth bore textile braid coextruded hoses.
Designed solution for refrigeration systems and for domestic and industrial HVAC applications.
- **Working temperatures:**
From -40°C to +120°C from -40°F to +248°F
Max. peak temperature 130°C / 266°F
With insulation maximum temperature limited to +110°C (230°F)
- **Working pressure:**
Safety ratio exceeding EN 1736 and ISO 13971 requirements
- **Vacuum rating:** 5 mbar
- **Specifications:**
Compliant with EN 1736, ISO 13971 class 1 and UL 1963.

Scheda tecnica - Datasheet



CODE	inch	mm	DN	inch	mm	bar	psi	mm	inch	g/m	lbs/ft	FERRULE CODE *
FR5T390N	1/4"	4.8	5	0.366	9.3	120	1740	50	1.969	55	0.037	BP316R7
FR5T490N	5/16"	6.4	6	0.461	11.7	120	1740	75	2.953	80	0.054	BP14R7
FR5T590N	3/8"	8.1	8	0.555	14.1	120	1740	90	3.543	105	0.071	BP516R1TV
FR5T690N	1/2"	11.1	11	0.667	17.7	120	1740	100	3.937	150	0.101	BP38R1TV
FR5T790N	5/8"	13.9	14	0.811	20.6	120	1740	125	4.921	190	0.128	BP12R1TV
FR5T890N	3/4"	17.0	17	0.980	24.9	120	1740	165	6.496	270	0.181	BP58R9R

Scheda tecnica - Datasheet (Versione preisolata / Pre-insulated version)



CODE	inch	mm	DN	inch	mm	bar	psi	mm	inch	g/m	lbs/ft	FERRULE CODE *
FR5T390NI	1/4"	4.8	5	1.074	27.3	120	1740	50	1.969	85	0.057	BP316R7
FR5T590NI	3/8"	8.1	8	1.263	32.1	120	1740	90	3.543	130	0.087	BP516R1TV
FR5T690NI	1/2"	11.1	11	1.393	35.4	120	1740	100	3.937	200	0.134	BP38R1TV
FR5T790NI	5/8"	13.9	14	1.519	38.6	120	1740	125	4.921	250	0.168	BP12R1TV
FR5T890NI	3/4"	17.0	17	1.692	43.0	120	1740	165	6.496	335	0.225	BP58R9R

* Solo per uso con pressa professionale / Professional crimping tool use only

Raccordi per tubo FR5T con pressa professionale / FR5T Hose Fittings with professional crimping tool

RACCORDO FEMMINA DIRITTA STRAIGHT FEMALE FITTING



RACCORDO FEMMINA 90° 90° FEMALE FITTING



Tubo / Hose	Codice / Part Nr.	Descrizione / Description	Pezzi / Pcs
FR5T390N 1/4"	FR5T3K001AA	FEMM. D. 1/4" SAE ACCIAIO AVP / S. FEM. 1/4" SAE CARBON STEEL	1
	FR5T3K025AA	FEMM. D. 1/4" SAE ACCIAIO AVP / S. FEM. 1/4" SAE CARBON STEEL	25
FR5T490N 5/16"	FR5T4K001AA	FEMM. D. 1/4" SAE ACCIAIO AVP / S. FEM. 1/4" SAE CARBON STEEL	1
	FR5T4K025AA	FEMM. D. 1/4" SAE ACCIAIO AVP / S. FEM. 1/4" SAE CARBON STEEL	25
	FR5T4K001AC	FEMM. D. 3/8" SAE ACCIAIO AVP / S. FEM. 3/8" SAE CARBON STEEL	1
	FR5T4K025AC	FEMM. D. 3/8" SAE ACCIAIO AVP / S. FEM. 3/8" SAE CARBON STEEL	25
FR5T590N 3/8"	FR5T5K001AC	FEMM. D. 3/8" SAE ACCIAIO AVP / S. FEM. 3/8" SAE CARBON STEEL	1
	FR5T5K025AC	FEMM. D. 3/8" SAE ACCIAIO AVP / S. FEM. 3/8" SAE CARBON STEEL	25
FR5T690N 1/2"	FR5T6K001AD	FEMM. D. 1/2" SAE ACCIAIO AVP / S. FEM. 1/2" SAE CARBON STEEL	1
	FR5T6K025AD	FEMM. D. 1/2" SAE ACCIAIO AVP / S. FEM. 1/2" SAE CARBON STEEL	25
FR5T790N 5/8"	FR5T7K001AE	FEMM. D. 5/8" SAE ACCIAIO AVP / S. FEM. 5/8" SAE CARBON STEEL	1
	FR5T7K025AE	FEMM. D. 5/8" SAE ACCIAIO AVP / S. FEM. 5/8" SAE CARBON STEEL	25
FR5T890N 3/4"	FR5T8K001AF	FEMM. D. 3/4" SAE ACCIAIO AVP / S. FEM. 3/4" SAE CARBON STEEL	1
	FR5T8K025AF	FEMM. D. 3/4" SAE ACCIAIO AVP / S. FEM. 3/4" SAE CARBON STEEL	25

Tubo / Hose	Codice / Part Nr.	Descrizione / Description	Pezzi / Pcs
FR5T390N 1/4"	FR5T3K001BA	FEMM. 90° 1/4" SAE ACCIAIO AVP / 90° FEM. 1/4" SAE CARBON STEEL	1
	FR5T3K025BA	FEMM. 90° 1/4" SAE ACCIAIO AVP / 90° FEM. 1/4" SAE CARBON STEEL	25
FR5T490N 5/16"	FR5T4K001BA	FEMM. 90° 1/4" SAE ACCIAIO AVP / 90° FEM. 1/4" SAE CARBON STEEL	1
	FR5T4K025BA	FEMM. 90° 1/4" SAE ACCIAIO AVP / 90° FEM. 1/4" SAE CARBON STEEL	25
	FR5T4K001BC	FEMM. 90° 3/8" SAE ACCIAIO AVP / 90° FEM. 3/8" SAE CARBON STEEL	1
	FR5T4K025BC	FEMM. 90° 3/8" SAE ACCIAIO AVP / 90° FEM. 3/8" SAE CARBON STEEL	25
FR5T590N 3/8"	FR5T5K001BC	FEMM. 90° 3/8" SAE ACCIAIO AVP / 90° FEM. 3/8" SAE CARBON STEEL	1
	FR5T5K025BC	FEMM. 90° 3/8" SAE ACCIAIO AVP / 90° FEM. 3/8" SAE CARBON STEEL	25
FR5T690N 1/2"	FR5T6K001BD	FEMM. 90° 1/2" SAE ACCIAIO AVP / 90° FEM. 1/2" SAE CARBON STEEL	1
	FR5T6K025BD	FEMM. 90° 1/2" SAE ACCIAIO AVP / 90° FEM. 1/2" SAE CARBON STEEL	25
FR5T790N 5/8"	FR5T7K001BE	FEMM. 90° 5/8" SAE ACCIAIO AVP / 90° FEM. 5/8" SAE CARBON STEEL	1
	FR5T7K025BE	FEMM. 90° 5/8" SAE ACCIAIO AVP / 90° FEM. 5/8" SAE CARBON STEEL	25
FR5T890N 3/4"	FR5T8K001BF	FEMM. 90° 3/4" SAE ACCIAIO AVP / 90° FEM. 3/4" SAE CARBON STEEL	1
	FR5T8K025BF	FEMM. 90° 3/4" SAE ACCIAIO AVP / 90° FEM. 3/4" SAE CARBON STEEL	25

Tubo / Hose	Codice / Part Nr.	Descrizione / Description	Pezzi / Pcs
FR5T390N 1/4"	FR5T3K001DA	TUBOLARE IN RAME 1/4" / COPPER PIPE 1/4"	1
	FR5T3K025DA	TUBOLARE IN RAME 1/4" / COPPER PIPE 1/4"	25
FR5T490N 5/16"	FR5T4K001DB	TUBOLARE IN RAME 5/16" / COPPER PIPE 5/16"	1
	FR5T4K025DB	TUBOLARE IN RAME 5/16" / COPPER PIPE 5/16"	25
FR5T590N 3/8"	FR5T5K001DC	TUBOLARE IN RAME 3/8" / COPPER PIPE 3/8"	1
	FR5T5K025DC	TUBOLARE IN RAME 3/8" / COPPER PIPE 3/8"	25
FR5T690N 1/2"	FR5T6K001DD	TUBOLARE IN RAME 1/2" / COPPER PIPE 1/2"	1
	FR5T6K025DD	TUBOLARE IN RAME 1/2" / COPPER PIPE 1/2"	25
FR5T790N 5/8"	FR5T7K001DE	TUBOLARE IN RAME 5/8" / COPPER PIPE 5/8"	1
	FR5T7K025DE	TUBOLARE IN RAME 5/8" / COPPER PIPE 5/8"	25
FR5T890N 3/4"	FR5T8K001DF	TUBOLARE IN RAME 3/4" / COPPER PIPE 3/4"	1
	FR5T8K025DF	TUBOLARE IN RAME 3/4" / COPPER PIPE 3/4"	25

TUBOLARI IN RAME COPPER PIPES

* UP TO MAX. 60 BAR



Accessori serie FR5T / FR5T Series Accessories

UTENSILE OLEODINAMICO A BATTERIA
CORDLESS HYDRAULIC CRIMPING TOOL



SPLIT
Procedura di montaggio elettrico
Electric assembly procedure

Codice / Part Nr.

PZBCFR5T130



UTENSILE OLEODINAMICO MANUALE
HYDRAULIC CRIMPING TOOL



SPLIT
Procedura di montaggio manuale
Manual assembly procedure

Codice / Part Nr.

PZMCFR5T130



Matrici / Die set	Codice Tubo / Hose Code	inch	Raccordi / Fittings	Descrizione / Description	Raccordi / Fittings	Descrizione / Description
MPZBCFR51303	FR5T390N/I DN5	1/4"	FR5T3K001AA	FEMM. D. 1/4" SAE / S. FEM. 1/4" SAE	FR3T3K001DA	TUB. IN RAME 1/4" / COPPER PIPE 1/4"
			FR5T3K001BA	FEMM. 90° 1/4" SAE / 90° FEM. 1/4" SAE		
MPZBCFR51304	FR5T490N DN6	5/16"	FR5T4K001AA	FEMM. D. 1/4" SAE / S. FEM. 1/4" SAE	FR5T4K001DB	TUB. IN RAME 5/16" / COPPER PIPE 5/16"
			FR5T4K001BA	FEMM. 90° 1/4" SAE / 90° FEM. 1/4" SAE		
			FR5T4K001AC	FEMM. D. 3/8" SAE / S. FEM. 3/8" SAE		
			FR5T4K001BC	FEMM. 90° 3/8" SAE / 90° FEM. 3/8" SAE		
MPZBCFR51305	FR5T590N/I DN8	3/8"	FR5T5KP01AC	FEMM. D. 3/8" SAE / S. FEM. 3/8" SAE	FR5T5KP01DC	TUB. IN RAME 3/8" / COPPER PIPE 3/8"
			FR5T5KP01BC	FEMM. 90° 3/8" SAE / 90° FEM. 3/8" SAE		
MPZBCFR51306	FR5T690N/I DN11	1/2"	FR5T6KP01AD	FEMM. D. 1/2" SAE / S. FEM. 1/2" SAE	FR5T6KP01DD	TUB. IN RAME 1/2" / COPPER PIPE 1/2"
			FR5T6KP01BD	FEMM. 90° 1/2" SAE / 90° FEM. 1/2" SAE		
MPZBCFR51307	FR5T790N/I DN14	5/8"	FR5T7KP01AE	FEMM. D. 5/8" SAE / S. FEM. 5/8" SAE	FR5T7KP01DE	TUB. IN RAME 5/8" / COPPER PIPE 5/8"
			FR5T7KP01BE	FEMM. 90° 5/8" SAE / 90° FEM. 5/8" SAE		

Istruzioni di assemblaggio per serie FR5T Capillari e Tubo FR5T disponibili su www.zecspa.com/it/supporto-tecnico.

Assembly instructions for FR5T Capillary and FR5T Hose availables on www.zecspa.com/en/technical-support.

Tubi FR5A

Dall'impegno di ZED nella ricerca di soluzioni eco-sostenibili per i sistemi di refrigerazione e aria condizionata nasce una gamma speciale di tubi per la CO₂ (R744).

La serie FR5A, realizzata con una treccia di rinforzo in acciaio, resiste ad una pressione di 130 bar ed una temperatura di picco di 130°C massimizzando le prestazioni dell'intero sistema.

FR5A Hoses

ZEC has conducted an intensive research into sustainable and energy-efficient solutions for HVAC.

Recognizing the shift toward ecological responsibility, ZEC has developed a special hose series with a steel reinforcement braiding. The FR5A hoses resist to a pressure of 130 bar and a peak temperature of 130°C, optimizing the performance of the entire system.





WE ARE PART OF THE
SOLUTION



TUBI FR5A FR5A HOSES



Caratteristiche tecniche

- **Caratteristiche tecnico-costruttive:**
Tubi coestrusi treccia acciaio. Soluzione ideale per utilizzo CO2 su impianti di refrigerazione industriale e commerciale.
- **Temperature di utilizzo:**
Da -40°C a +120°C
Temperatura di picco max. 130°C
- **Pressioni d'esercizio:**
Rapporto di sicurezza superiore ai requisiti della EN 1736 e ISO 13971
- **Valore max. di vuoto:** 5 mbar
- **Specifiche:**
Conformi alla norme EN 1736, ISO 13971 classe 1 e UL 1963.

Technical Features

- **Technical-constructive features:**
Steel braid coextruded hoses. Designed solution for CO2 systems on industrial and commercial refrigeration systems.
- **Working temperatures:**
*From -40°C to +120°C from -40°F to +248°F
Max. peak temperature 130°C / 266°F*
- **Working pressure:**
Safety ratio exceeding EN 1736 and ISO 13971 requirements
- **Vacuum rating:** 5 mbar
- **Specifications:**
Compliant with EN 1736, ISO 13971 class 1 and UL 1963.

Scheda tecnica - Datasheet



CODE	inch	mm	DN	inch	mm	bar	psi	mm	inch	g/m	lbs/ft	FERRULE CODE *
FR5A430N	5/16"	6.4	6	0.468	11.9	130	1885	40	1.575	130	0.087	BP14MT1
FR5A530N	3/8"	8.1	8	0.551	14.0	130	1885	50	1.968	200	0.134	BP516R7V
FR5A630N	1/2"	11.1	11	0.685	17.4	130	1885	80	3.150	255	0.171	BP38R1TV
FR5A730N	5/8"	13.9	14	0.791	20.1	130	1885	120	4.724	320	0.215	BP12R7V

* Solo per uso con pressa professionale / Professional crimping tool use only

Raccordi per tubo FR5A con pressa professionale / FR5A Hose Fittings with professional crimping tool

RACCORDO FEMMINA DIRITTA
STRAIGHT FEMALE FITTING



RACCORDO FEMMINA 90°
90° FEMALE FITTING



Tubo / Hose	Codice / Part Nr.	Descrizione / Description	Pezzi / Pcs
FR5A430N 5/16"	FR5A4K001AA	FEMM. D. 1/4" SAE ACCIAIO AVP / S. FEM. 1/4" SAE CARBON STEEL	1
	FR5A4K025AA	FEMM. D. 1/4" SAE ACCIAIO AVP / S. FEM. 1/4" SAE CARBON STEEL	25
	FR5A4K001AC	FEMM. D. 3/8" SAE ACCIAIO AVP / S. FEM. 3/8" SAE CARBON STEEL	1
	FR5A4K025AC	FEMM. D. 3/8" SAE ACCIAIO AVP / S. FEM. 3/8" SAE CARBON STEEL	25
FR5A530N 3/8"	FR5A5K001AC	FEMM. D. 3/8" SAE ACCIAIO AVP / S. FEM. 3/8" SAE CARBON STEEL	1
	FR5A5K025AC	FEMM. D. 3/8" SAE ACCIAIO AVP / S. FEM. 3/8" SAE CARBON STEEL	25
FR5A630N 1/2"	FR5A6K001AD	FEMM. D. 1/2" SAE ACCIAIO AVP / S. FEM. 1/2" SAE CARBON STEEL	1
	FR5A6K025AD	FEMM. D. 1/2" SAE ACCIAIO AVP / S. FEM. 1/2" SAE CARBON STEEL	25
FR5A730N 5/8"	FR5A7K001AE	FEMM. D. 5/8" SAE ACCIAIO AVP / S. FEM. 5/8" SAE CARBON STEEL	1
	FR5A7K025AE	FEMM. D. 5/8" SAE ACCIAIO AVP / S. FEM. 5/8" SAE CARBON STEEL	25

Tubo / Hose	Codice / Part Nr.	Descrizione / Description	Pezzi / Pcs
FR5A430N 5/16"	FR5A4K001BA	FEMM. 90° 1/4" SAE ACCIAIO AVP / 90° FEM. 1/4" SAE CARBON STEEL	1
	FR5A4K025BA	FEMM. 90° 1/4" SAE ACCIAIO AVP / 90° FEM. 1/4" SAE CARBON STEEL	25
	FR5A4K001BC	FEMM. 90° 3/8" SAE ACCIAIO AVP / 90° FEM. 3/8" SAE CARBON STEEL	1
	FR5A4K025BC	FEMM. 90° 3/8" SAE ACCIAIO AVP / 90° FEM. 3/8" SAE CARBON STEEL	25
FR5A530N 3/8"	FR5A5K001BC	FEMM. 90° 3/8" SAE ACCIAIO AVP / 90° FEM. 3/8" SAE CARBON STEEL	1
	FR5A5K025BC	FEMM. 90° 3/8" SAE ACCIAIO AVP / 90° FEM. 3/8" SAE CARBON STEEL	25
FR5A630N 1/2"	FR5A6K001BD	FEMM. 90° 1/2" SAE ACCIAIO AVP / 90° FEM. 1/2" SAE CARBON STEEL	1
	FR5A6K025BD	FEMM. 90° 1/2" SAE ACCIAIO AVP / 90° FEM. 1/2" SAE CARBON STEEL	25
FR5A730N 5/8"	FR5A7K001BE	FEMM. 90° 5/8" SAE ACCIAIO AVP / 90° FEM. 5/8" SAE CARBON STEEL	1
	FR5A7K025BE	FEMM. 90° 5/8" SAE ACCIAIO AVP / 90° FEM. 5/8" SAE CARBON STEEL	25

Tubo / Hose	Codice / Part Nr.	Descrizione / Description	Pezzi / Pcs
FR5A490N 5/16"	FR5A4K001DB	TUBOLARE IN RAME 5/16" / COPPER PIPE 5/16"	1
	FR5A4K025DB	TUBOLARE IN RAME 5/16" / COPPER PIPE 5/16"	25
FR5A590N 3/8"	FR5A5K001DC	TUBOLARE IN RAME 3/8" / COPPER PIPE 3/8"	1
	FR5A5K025DC	TUBOLARE IN RAME 3/8" / COPPER PIPE 3/8"	25
FR5A690N 1/2"	FR5A6K001DD	TUBOLARE IN RAME 1/2" / COPPER PIPE 1/2"	1
	FR5A6K025DD	TUBOLARE IN RAME 1/2" / 90° FEM. FIT. 1/2" SAE	25
FR5A790N 5/8"	FR5A7K001DE	TUBOLARE IN RAME 5/8" / COPPER PIPE 5/8"	1
	FR5A7K025DE	TUBOLARE IN RAME 5/8" / COPPER PIPE 5/8"	25

TUBOLARI IN RAME
COPPER PIPES

* UP TO MAX. 60 BAR



Istruzioni di saldatura ermeti in rame

Per la corretta saldatura degli ermeti in rame al circuito frigorifero, è importante proteggere il tubo termoplastico dal calore eccessivo provocato dalla saldatura.

Un riscaldamento oltre la temperatura di esercizio dichiarata può compromettere l'utilizzo del tubo. Prima di iniziare la saldatura, avvolgere uno straccio bagnato attorno al raccordo. Una volta completata la saldatura, raffreddare velocemente il pezzo con acqua fredda. Per evitare il calore è possibile utilizzare anche una pasta anticalore o una pistola ad aria fredda.

Copper pipe welding instructions

For the correct welding of the copper pipe to the refrigerant circuit, it is important to protect the thermoplastic hose from the excessive heat caused by the welding. Heating beyond the declared working temperature can compromise the use of the hose.

Before starting welding, wrap a wet rag around the fittings. Once the welding is complete, quickly cool the part with cold water. To avoid heat you can also use a hot block paste or a cold air gun.



TUBI FR5C

FR5C HOSES



Caratteristiche tecniche

- **Caratteristiche tecnico-costruttive:**
Anima interna corrugata in poliammide modificata. Rinforzo con una treccia in acciaio INOX AISI 304.
- **Applicazioni:**
I tubi FR5C sono stati progettati per lo smorzamento delle vibrazioni e per l'assorbimento acustico, negli impianti di refrigerazione e condizionamento.
- **Temperature di utilizzo:**
Da -40°C a +120°C
Temperatura di picco max. 130°C
- **Pressioni d'esercizio:**
Rapporto di sicurezza 1:3 (EN 1736)
- **Valore max. di vuoto:** 5 mbar
- **Specifiche:**
Conformi alle norme EN 1736 e ISO 13971 classe 2, soddisfano i requisiti della norma UL1963.

Disponibile solo raccordato, con tubolari in rame.

Technical Features

- **Technical-constructive features:**
Corrugated inner core in modified polyamide. Reinforcement with one AISI 304 steel braid.
- **Applications:**
FR5C hoses have been developed for vibration damping and noise absorption of refrigeration and air conditioning systems.
- **Working temperatures:**
From -40°C to +120°C from -40°F to +248°F
Max. peak temperature 130°C / 266°F
- **Working pressure:**
Safety ratio 1:3 (EN 1736)
- **Vacuum rating:** 5 mbar
- **Specifications:**
Compliant with EN 1736 and ISO 13971 class 2, meet UL1963 requirements.

Available only pre-assembled, with copper pipes.

Scheda tecnica - Datasheet



CODE	inch	mm	DN	inch	mm	bar	psi	mm	inch	g/m	lbs/ft	FERRULE CODE *
FR5C800	3/4"	18.0	18	0.996	25.3	50	725	150	5.90	410	0.276	BP34FR5IC
FR5C900	7/8"	21.2	21	1.181	30.0	50	725	200	7.87	450	0.302	BP78FR5IC
FR5C1000	1"1/8	28.2	28	1.499	38.0	50	725	250	9.84	630	0.423	BP118FR5IC

* Solo per uso con pressa professionale / Professional crimping tool use only

TUBI CARICA TLP TLP CHARGING HOSES



Caratteristiche tecniche

- Caratteristiche tecnico-costruttive:**

L'anima interna dei tubi carica TLP è realizzata in una speciale lega costituita da poliammide (PA) ed elastomero termoplastico (TPE). Oltre a conferire una grande flessibilità al tubo, questo materiale garantisce una bassa permeabilità al refrigerante, riducendo al minimo le fughe di gas attraverso il tubo.

- Applicazioni:**

I tubi carica ZEC TLP sono appositamente sviluppati per stazioni di carica di gas refrigerante. Sono caratterizzati da un basso valore del raggio minimo di curvatura ed una conseguente superiore resistenza all'effetto "kinking", se confrontati con i tradizionali tubi in elastomero di equivalenti prestazioni.

- Temperature di utilizzo:**

La temperatura di esercizio dei tubi carica TLP è compresa nel range tra -30°C e +95°C.

- Specifiche:**

Conformi alle normative SAE J2196 e SAE J2888, soddisfano i requisiti della norma UL 1963.

Technical Features

- Technical-constructive features:**

The inner core of TLP charging hoses is made of a special alloy composed of polyamide (PA) and thermoplastic elastomer (TPE). In addition to making the hose extremely flexible, this material ensures low permeability to refrigerants, thus minimizing gas leaks through the hose.

- Applications:**

TLP charging hoses are specifically developed for refrigerant gas recharging stations. TLP charging hoses feature low values of minimum bending radius and, consequently, higher resistance to kinking, if compared with traditional elastomeric hoses of equivalent performance.

- Working temperatures:**

The working temperature of TLP charging hoses is in the range from -30°C to +95°C.

- Specifications:**

Compliant with SAE J2196 and SAE J2888, meet UL 1963 requirements.

Scheda tecnica - Datasheet



CODE	Colore / Colour	inch	mm	inch	mm	bar	psi	mm	inch	FERRULE CODE
TLP1085361**	● ● ● ●	0.209	5.3	0.425	10.8	60	870	30	1.18	BP53FR5TOT
TLP461**	● ● ● ●	0.315	8.0	0.559	14.2	60	870	40	1.57	BP80FR5TOT

* Disponibili pre-assemblati, già raccordati / Available pre-assembled, with fittings installed

N.B. Nel codice compare **, bisogna sostituirlo con la sigla del colore del tubo: NERO (00), BLU (02), GIALLO (04) o ROSSO (21). Esempio: Tubo TLP1085361** nero – codice TLP108536100.

N.B. In the code there is **, this must be replaced with the color code of the tube: BLACK (00), BLUE (02), YELLOW (04) or RED (21) Example: Tube TLP1085361** black – code TLP108536100.

Raccordi per tubo carica TLP / TLP Charging Hose Fittings

RACCORDO FEMMINA DIRITTA 1/4" SAE
1/4" SAE STRAIGHT FEMALE FITTING



Codice / Part Nr.	Pezzi / Pcs
TLP53K001AA	1
TLP53K025AA	25
TLP53K050AA	50

RACCORDO FEMMINA 45° 1/4" SAE
1/4" SAE 45° FEMALE FITTING



Codice / Part Nr.	Pezzi / Pcs
TLP53K001QA	1
TLP53K025QA	25
TLP53K050QA	50

RACCORDO FEMMINA DRITTA 5/16" SAE
5/16" SAE STRAIGHT FEMALE FITTING



Codice / Part Nr.	Pezzi / Pcs
TLP53K001AB	1
TLP53K025AB	25
TLP53K050AB	50

RACCORDO FEMMINA 45° 5/16" SAE
5/16" SAE 45° FEMALE FITTING



Codice / Part Nr.	Pezzi / Pcs
TLP53K001QB	1
TLP53K025QB	25
TLP53K050QB	50

RACCORDO MASCHIO DRITTO 12X1,5MM
12X1,5MM STRAIGHT MALE FITTING



Codice / Part Nr.	Pezzi / Pcs
TLP53K001Z	1
TLP53K025Z	25
TLP53K050Z	50

RACCORDO MASCHIO DRITTO 14X1,5MM
14X1,5MM STRAIGHT MALE FITTING



Codice / Part Nr.	Pezzi / Pcs
TLP53K001W	1
TLP53K025W	25
TLP53K050W	50

Raccordi per tubo carica TLP / TLP Charging Hose Fittings

RACCORDO FEMMINA DRITTA 1/4" SAE DADO CH.15MM
1/4" SAE 15MM NUT STRAIGHT FEMALE FITTING



Codice / Part Nr.	Pezzi / Pcs
TLP53K001AAA	1
TLP53K025AAA	25
TLP53K050AAA	50

RACCORDO FEMMINA 90° 1/4" SAE DADO CH.15MM
1/4" SAE 15MM NUT 90° FEMALE FITTING

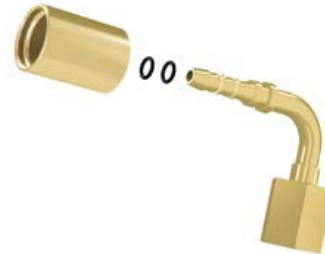

Codice / Part Nr.	Pezzi / Pcs
TLP53K001BAA	1
TLP53K025BAA	25
TLP53K050BAA	50

RACCORDO MASCHIO DRITTO 1/8" NPTF
1/8" NPTF STRAIGHT MALE FITTING



Codice / Part Nr.	Pezzi / Pcs
TLP53K001NS	1
TLP53K025NS	25
TLP53K050NS	50

RACCORDO FEMMINA DRITTA O-RING 1/4" DADO 15MM
1/4" O-RING SEAL 15MM NUT STRAIGHT FEMALE FITTING



Codice / Part Nr.	Pezzi / Pcs
TLP53K001JAA	1
TLP53K025JAA	25
TLP53K050JAA	50

RACCORDO FEMMINA DRITTA 1/2" - 16 ACME
1/2" - 16 ACME STRAIGHT FEMALE FITTING



Codice / Part Nr.	Pezzi / Pcs
TLP53K001V	1
TLP53K025V	25
TLP53K050V	50

Raccordi per tubo carica TLP DN8 / TLP Charging Hose Fittings DN8

RACCORDO FEMMINA DRITTA 3/8" SAE
3/8" SAE STRAIGHT FEMALE FITTING



Codice / Part Nr.	Pezzi / Pcs
TLP80K001AC	1
TLP80K025AC	25
TLP80K050AC	50

RACCORDO FEMMINA 45° 3/8" SAE
3/8" SAE 45° FEMALE FITTING



Codice / Part Nr.	Pezzi / Pcs
TLP80K001QC	1
TLP80K025QC	25
TLP80K050QC	50

Accessori serie TLP / TLP Series Accessories

GUARNIZIONE NBR TLP53
ESTERNO FEM. 1/4"- ACME 1/2"
NBR GASKET TLP53
EXTERNAL FEM. 1/4"- ACME 1/2"



Codice / Part Nr.	Pezzi / Pcs
YORC855KC	50

GUARNIZIONE HNBR TLP53
ESTERNO FEM. 5/16"
HNBR GASKET TLP53
EXTERNAL FEM. 5/16"



Codice / Part Nr.	Pezzi / Pcs
YORC9355KC	50

GUARNIZIONE FKM TLP53 INTERNO TUBO
FKM GASKET TLP53 INTERNAL



Codice / Part Nr.	Pezzi / Pcs
YOR351VKC	50

GUARNIZIONE HNBR TLP53
ESTERNO M12X1.5
HNBR GASKET TLP53
EXTERNAL M12X1.5



Codice / Part Nr.	Pezzi / Pcs
YORH92517KC	50

GUARNIZIONE HNBR TLP53
ESTERNO M14X1.5
HNBR GASKET TLP53
EXTERNAL M14X1.5



Codice / Part Nr.	Pezzi / Pcs
YORH10817KC	50

DEPRESSORE
DEPRESSOR



Codice / Part Nr.	Pezzi / Pcs
VFRC53KC	50

Accessori serie TLP / TLP Series Accessories

UTENSILE OLEODINAMICO PER CRIMPAGGIO BOCCOLE DN2-4-6
FLUID POWER CRIMPING TOOL FOR DN2-4-6 FERRULES



TLP
 Procedura di montaggio elettrico
Electric assembly procedure

Codice / Part Nr.

PZBCFR5



PINZA A CRIMPARE PER BOCCOLE DN2-4-6
CRIMPING TOOL FOR DN2-4-6 FERRULES

Codice / Part Nr.

PZFR5DN4



Matrici / Die set	Codice Tubo / Hose Code	mm	Raccordi / Fittings	Descrizione / Description
MPZBCTLPDN53	TLP108536100 TLP108536102 TLP108536104 TLP108536121	5.3	TLP53K001AA	FEMMINA DRITTA 1/4" SAE / 1/4" SAE STRAIGHT FEMALE
			TLP53K001QA	FEMMINA 45° 1/4" SAE / 1/4" SAE 45° FEMALE
			TLP53K001AB	FEMMINA DRITTA 5/16" SAE / 5/16" SAE STRAIGHT FEMALE
			TLP53K001QB	FEMMINA 45° 5/16" SAE / 5/16" SAE 45° FEMALE
			TLP53K001Z	MASCHIO DRITTO 12X1,5MM / 14X1,5MM STRAIGHT MALE
			TLP53K001W	MASCHIO DRITTO 14X1,5MM / 14X1,5MM STRAIGHT MALE
			TLP53K001AAA	FEMMINA DRITTA 1/4" SAE DADO CH.15MM / 1/4" SAE 15MM NUT STRAIGHT FEMALE
			TLP53K001BAA	FEMMINA 90° 1/4" SAE DADO CH.15MM / 1/4" SAE 15MM NUT 90° FEMALE
			TLP53K001NS	MASCHIO DRITTO 1/8" NPTF / 1/8" NPTF STRAIGHT MALE
			TLP53K001JAA	FEMMINA DRITTA O-RING 1/4" DADO 15MM 1/4" / 1/4" O-RING SEAL 15MM NUT STRAIGHT FEMALE
			TLP53K001V	FEMMINA DRITTA 1/2" - 16 ACME / 1/2" - 16 ACME STRAIGHT FEMALE

INDICAZIONI DI MONTAGGIO INSTALLATION INSTRUCTIONS (SAE J1273 - ISO 8331)

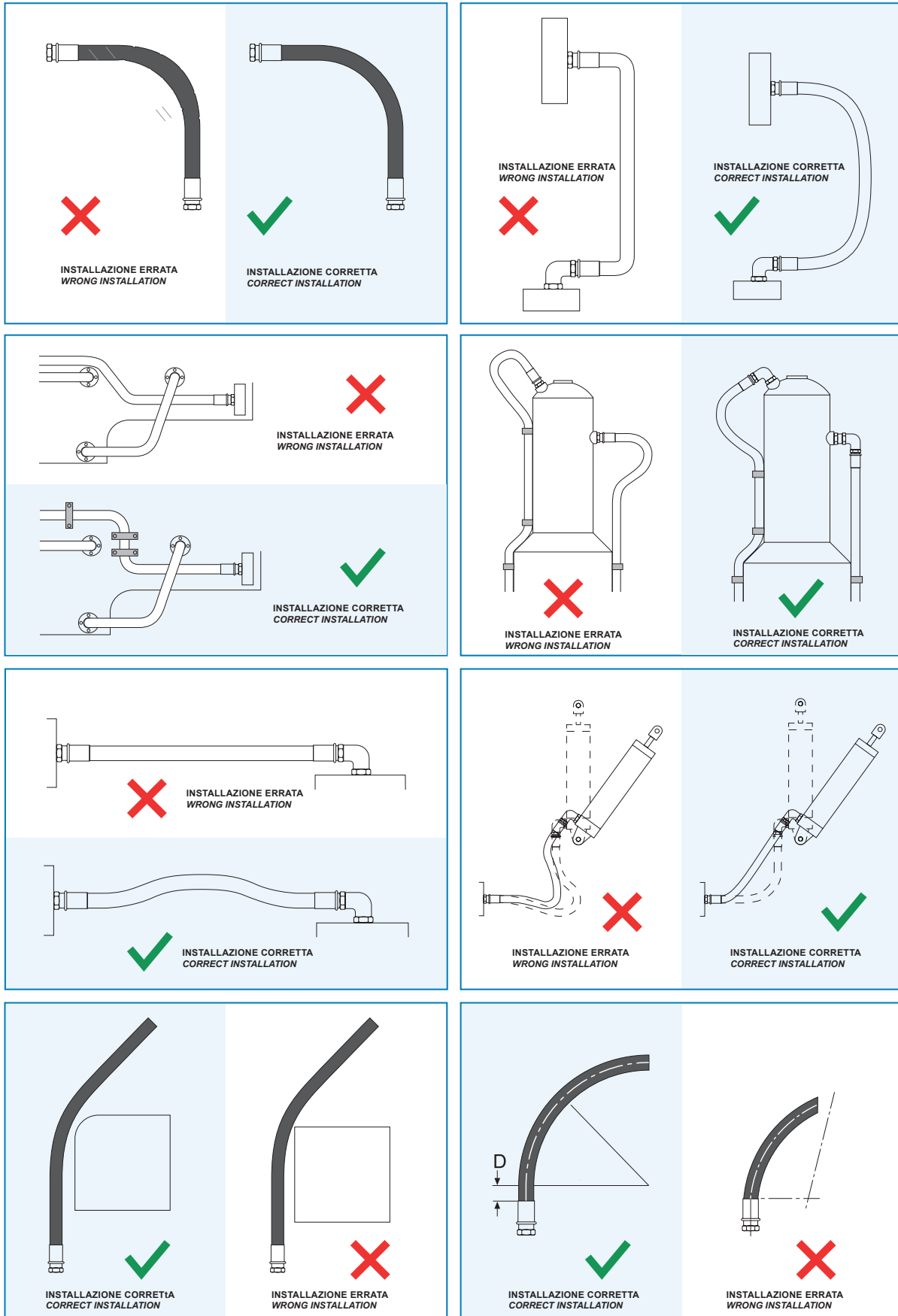

Performance dei tubi / *Hose Performance* (secondo / *according to* ISO 13971 - EN 1736)

Performance dei tubi raccordati da ZEC / *Hose performance assembled at our plant*

TS	WT	PS
-40° +130° C	-40° +120° C	120 bar
-40° +266° F	-40° +248° F	1740 psi

TS	WT	PS
-40° +130° C	-40° +120° C	130 bar
-40° +266° F	-40° +248° F	1885 psi

TS = temperature minime e massime ammissibili
minimum and maximum allowable temperatures

WT = temperature minime e massime di lavoro
working temperatures

PS = pressione massima ammissibile
maximum allowable pressure



Performance del tubo, raccordato con pressa PZBCFR5T130 / *Hose performance assembled with our PZBCFR5T130*

TS	WT	PS
-40° +120° C	-40° +110° C	60 bar
-40° +248° F	-40° +230° C	870 psi





THERMOPLASTIC TUBING AND HOSES
MADE IN ITALY

Le immagini e i valori menzionati in questo documento sono forniti a titolo puramente indicativo al fine di consentire una prima valutazione sulle possibilità di impiego dei prodotti. La Nostra produzione potrà essere variata senza impegno di alcun preavviso alla Nostra clientela.

Si raccomanda di verificare sul sito www.zecspa.com la presenza di possibili adeguamenti per scaricare le schede tecniche di prodotto aggiornate.

È responsabilità del cliente verificare che i tubi e i raccordi siano adatti alla propria applicazione e soddisfino le specifiche e gli standard richiesti.

Per condizioni di vendita: www.zecspa.com/it/condizioni-general-di-vendita.



Condizioni generali di vendita

The images and values indicated in the present document are to be intended only as an indication, with the purpose of permitting the customer a first evaluation of the products application possibilities. Our production can be modified without any obligation of prior notice to our customers.

Therefore we recommend to consult our website www.zecspa.com for the latest version of the technical data sheets.

It's the Customer's responsibility to check that hoses and fittings are suitable for his application and meet the required specifications and standards.

For Terms of Sale please refer to www.zecspa.com/en/general-conditions-of-sale.



General conditions of sale



THERMOPLASTIC TUBING AND HOSES
MADE IN ITALY

ZEC S.p.A.
Via Lungolorno 11, 43052 Colorno (PR) - Italy
Tel. +39 0521 816631 - Fax +039 0521 816772

www.zecspa.com
info@zecspa.com

